

Operating Instructions

Panasonic®

DVD Recorder

Model No. **DMR-EX88**
DMR-EX78

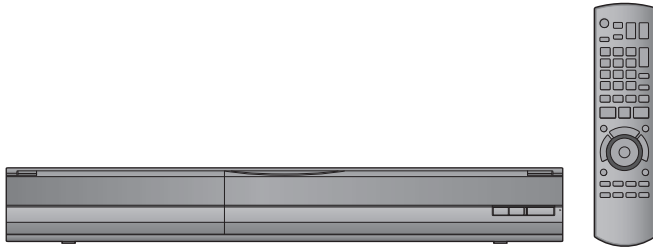

The illustrations in these Operating Instructions show images of DMR-EX78 unless otherwise indicated.



Instructions/notes regarding SD Cards and SD drive are applicable to the DMR-EX88 model only.

Region number supported by this unit

Region numbers are allocated to DVD Recorders and DVD-Video according to where they are sold.

- The region number of this unit is "4".
- The unit will play DVD-Video marked with labels containing "4" or "ALL".

Example:



Quick Start Guide

Basic operations

Dear customer

Thank you for purchasing this product. For optimum performance and safety, please read these instructions carefully.

Before connecting, operating or adjusting this product, please read the instructions completely. Please keep this manual for future reference.

This DVD recorder is for viewing and recording free to view channels only, not pay TV or encrypted channels.

TV Guide system of this DVD recorder does not support analogue broadcasts.

Trademark of the DVB Digital Video Broadcasting Project (1991 to 1996)
Declaration of Conformity (16th November 2007)

No. 5153 (DMR-EX78), No. 5154 (DMR-EX88)

Notice for DVB functions

- Any function related to DVB (Digital Video Broadcasting) will work in areas where DVB-T (MPEG2) digital terrestrial broadcasting is received. Consult your local Panasonic dealer with coverage areas.
- This unit has the capability for DVB specifications. But future DVB services cannot be guaranteed.
- This unit does not support MHP (Multimedia Home Platform).

DIGA

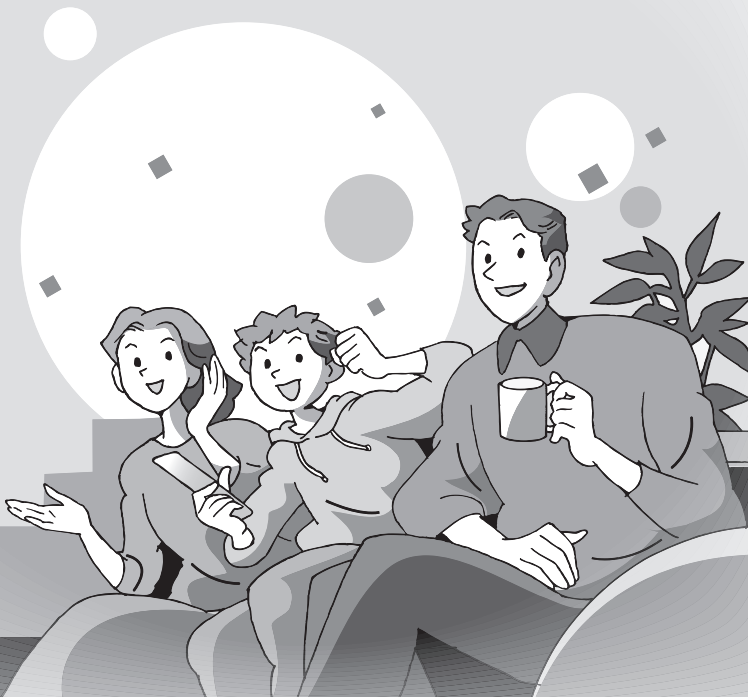

CAUTION!

THIS PRODUCT UTILIZES A LASER.
USE OF CONTROLS OR ADJUSTMENTS OR
PERFORMANCE OF PROCEDURES OTHER THAN THOSE
SPECIFIED HEREIN MAY RESULT IN HAZARDOUS
RADIATION EXPOSURE.
DO NOT OPEN COVERS AND DO NOT REPAIR YOURSELF.
REFER SERVICING TO QUALIFIED PERSONNEL.

WARNING:

TO REDUCE THE RISK OF FIRE, ELECTRIC SHOCK OR
PRODUCT DAMAGE,

- DO NOT EXPOSE THIS APPARATUS TO RAIN, MOISTURE,
DRIPPING OR SPLASHING AND THAT NO OBJECTS
FILLED WITH LIQUIDS, SUCH AS VASES, SHALL BE
PLACED ON THE APPARATUS.
- USE ONLY THE RECOMMENDED ACCESSORIES.
- DO NOT REMOVE THE COVER (OR BACK); THERE ARE
NO USER SERVICEABLE PARTS INSIDE. REFER
SERVICING TO QUALIFIED SERVICE PERSONNEL.

CAUTION!

- DO NOT INSTALL OR PLACE THIS UNIT IN A BOOKCASE,
BUILT-IN CABINET OR IN ANOTHER CONFINED SPACE.
ENSURE THE UNIT IS WELL VENTILATED. TO PREVENT
RISK OF ELECTRIC SHOCK OR FIRE HAZARD DUE TO
OVERHEATING, ENSURE THAT CURTAINS AND ANY
OTHER MATERIALS DO NOT OBSTRUCT THE
VENTILATION VENTS.
- DO NOT OBSTRUCT THE UNIT'S VENTILATION OPENINGS
WITH NEWSPAPERS, TABLECLOTHS, CURTAINS, AND
SIMILAR ITEMS.
- DO NOT PLACE SOURCES OF NAKED FLAMES, SUCH AS
LIGHTED CANDLES, ON THE UNIT.
- DISPOSE OF BATTERIES IN AN ENVIRONMENTALLY
FRIENDLY MANNER.

CAUTION

Danger of explosion if battery is incorrectly replaced. Replace
only with the same or equivalent type recommended by the
manufacturer. Dispose of used batteries according to the
manufacturer's instructions.

THIS UNIT IS INTENDED FOR USE IN MODERATE CLIMATES.

This product may receive radio interference caused by mobile
telephones during use. If such interference is apparent, please
increase separation between the product and the mobile
telephone.

The socket outlet shall be installed near the equipment and
easily accessible.
The mains plug of the power supply cord shall remain readily
operable.
To completely disconnect this apparatus from the AC Mains,
disconnect the power supply cord plug from AC receptacle.

CLASS 1
LASER PRODUCT



ANGER –VISIBLE AND INVISIBLE LASER RADIATION WHEN OPEN. AVOID DIRECT EXPOSURE TO BEAM. FDA 21 CFR/Class IIIb
CAUTION – CLASS 3B VISIBLE AND INVISIBLE LASER RADIATION WHEN OPEN. AVOID EXPOSURE TO THE BEAM. IEC60825-1 +A2/Class 3B
ATTENTION –RAYONNEMENT LASER VISIBLE ET INVISIBLE, CLASSE 3B, EN CAS D'OUVERTURE. EVITER UNE EXPOSITION AU FAISCEAU.
FORSIGTIG –SYNLIG OG USYNLIG LASERSTRÅLING KLASSE 3B, NÅR LÅGET ER ÅBENT. UNDSÅ AT BLIVE UDSTÅT FOR STRÅLEN.
VARO –AVATTAESSA OLET ALTTIINA LUOKAN 3B NÄKYVÄÄ JA NÄKYMÄTÖNTÄ LASERSÄTELYÄ. VARO ALTISTUMISTA SÄTEELLE.
VARNING –KLASS 3B SYNLIG OCH OSYNLIG LASERSTRÅLING NÄR DENNA DEL ÄR ÖPPNAD. UNDVIK EXPONERING FÖR STRÅLEN.
VORSICHT –SICHTBARE UND UNSICHTBARE LASERSTRÄHLUNG KLASSE 3B, WENN ABDECKUNG GEÖFFNET. NICHT DEM STRAHL AUSSETZEN.
注意 – 打开时有可见及不可见激光辐射。避免光束照射。
注意 – ここを開くと可視及び不可視レーザー光が出ます。 ビームを見たり、触れたりしないでください。 VQL-1J70

(Inside of product)

-If you see this symbol-

Information on Disposal in other Countries outside the European Union



This symbol is only valid in the European Union.
If you wish to discard this product, please contact your
local authorities or dealer and ask for the correct
method of disposal.

Getting started	
Included accessories	4
The remote control information	4
HDD (Hard disk drive) handling care	5
Unit care	5
Quick Start Guide	
Control reference guide	6
STEP 1 Connection	8
STEP 2 Channel reception settings and TV aspect settings	9
HDD and disc information	10
USB memory and card information	12
Regarding DivX files, MP3 files and still pictures (JPEG)	13
Media handling (Disc/USB memory/SD card)	14
Basic operations	
Watching analogue and digital broadcasts	15
Playing recorded video contents	
/Playing play-only discs	16
Recording television programmes	17
Timer recording	18
Deleting titles	19
Advanced operations	
Important notes for recording	20
Advanced recording	21
Recording modes and approximate recording times	21
When the format confirmation screen is displayed	21
When removing a recorded disc	21
Flexible Recording	22
Playing while you are recording	22
Copying from a video cassette recorder	23
Manual recording	23
DV automatic recording (DV Auto Rec)	23
Advanced timer recording	24
Using G-CODE system to make timer recordings (Analogue broadcast only)	24
Manually programming timer recordings	24
To cancel recording when recording has already begun	25
To release the unit from recording standby	25
Notes on timer recording	25
Check, change or delete a programme	25
Relief Recording	26
Auto Renewal Recording	26
Operations in the TV Guide system	27
Advanced playback	28
Operation during play	28
Changing audio during play	28
Selecting recorded programmes (titles) to play	
—Direct Navigator	29
Switching the Direct Navigator appearance	29
To sort the titles for easy searching	29
To play grouped titles HDD	29
To edit the group of titles HDD	29
Playing DivX, MP3 and still pictures	30
Showing the menu screen	30
Playing DivX video contents	30
Playing MP3 files	31
Playing still pictures	32
Useful functions during still picture play	33
Playing music	34
To play music CD	34
To play music recorded on HDD	34
Useful functions during music play	34
Convenient functions	35
FUNCTION MENU window	35
To pause the TV programme you are watching	
—Pause Live TV	35
Linked operations with the TV (VIERA Link “HDAVI Control™”)	36
Easy control only with VIERA remote control	37

Editing	
Editing titles/chapters	38
Creating, editing and playing playlists	40
Editing still pictures and music	42
Entering text	44
Copying	
Copying titles or playlists	45
Copy	46
Copying using the copying list—Advanced Copy	47
Copying a finalised DVD-R, DVD-R DL, DVD-RW (DVD-Video format), +R and +R DL	48
Copying SD Video from an SD card EX88	49
Copying SD Video from a video equipment EX88	49
Copying still pictures	50
Copying all the still pictures on the USB memory	
—Copy All Pictures	50
Copying new still pictures on the SD card	
—Copy New Pictures EX88	50
Copying using the copying list	50
Copying music to HDD	52
About the Gracenote® Database	52
Copying music from a CD	52
Copying music from a USB memory	52
To update the Gracenote® Database	53
Setting menus	
Using on-screen menus/Status message	54
HDD, disc and card management	56
Common procedures	56
Setting the protection	56
Providing a name for a disc	56
Deleting all titles and playlists—Delete all titles	57
Deleting all the contents—Format	57
Selecting the background style—Top Menu	58
Selecting whether to show the Top Menu first	
—Auto-Play Select	58
Enabling discs to be played on other equipment—Finalise	58
Creating Top Menu—Create Top Menu	58
Changing the unit’s settings	59
Common procedures	59
Tuning	59
Disc	61
Picture	62
Sound	62
Display	63
Connection	64
Others	65
Other Settings	67
Television operation	67
Child Lock	67
Reference	
Additional connections	68
Connecting a television with S VIDEO terminals	68
Connecting a television with COMPONENT VIDEO terminals	68
Connecting an amplifier with a digital input terminal	69
Connecting a stereo amplifier	69
Connecting with an HDMI compatible television and receiver	69
Connecting a television and VCR	70
Frequently asked questions	72
Messages	74
Troubleshooting guide	76
Specifications	83
Glossary	84
Safety precautions	86
Index	Back cover

About descriptions in these operating instructions
 The illustrations in these Operating Instructions show images of DMR-EX78 unless otherwise indicated.
EX88 : indicates features applicable to DMR-EX88 only.
EX78 : indicates features applicable to DMR-EX78 only.
 ● **Instructions/notes regarding SD cards and SD drive are applicable to the DMR-EX88 model only.**
 ● Pages to be referred to are indicated as “→ ○○”.

Included accessories



Please check and identify the supplied accessories.
(Product numbers correct as of April 2008. These may be subject to change.)



(N2QAYB000135)

1 **Remote control**

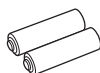

2 **Batteries**
for remote control



1 **AC mains lead**
For use with this unit only. Do not use it with other equipment.
Also, do not use cords for other equipment with this unit.



1 **RF coaxial cable**



1 **Audio/video cable**

The remote control information

■ Batteries

- Insert so the poles (+ and -) match those in the remote control.
- Do not use rechargeable type batteries.

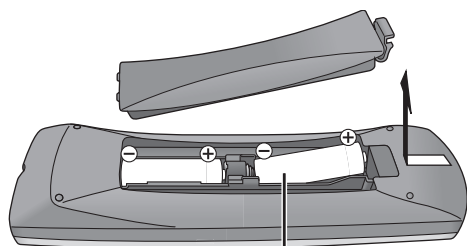

R6/LR6, AA

- Do not mix old and new batteries.
- Do not use different types at the same time.
- Do not heat or expose to flame.
- Do not leave the battery(ies) in an automobile exposed to direct sunlight for a long period of time with doors and windows closed.
- Do not take apart or short circuit.
- Do not attempt to recharge alkaline or manganese batteries.
- Do not use batteries if the covering has been peeled off.

Mishandling of batteries can cause electrolyte leakage which can damage items the fluid contacts and may cause a fire.

Remove if the remote control is not going to be used for a long period of time. Store in a cool, dark place.

Remote control operations (→ 6)

■ Use

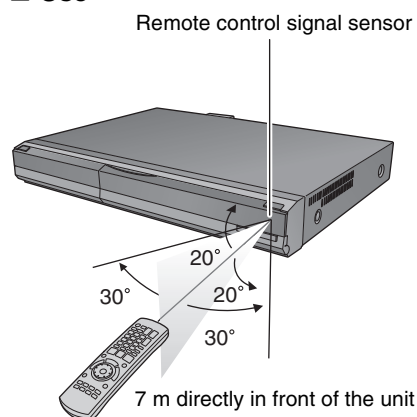

HDD (Hard disk drive) handling care

The HDD is a high precision recording instrument and because of its long recording capability and high speed operation it is a very special device that is easily susceptible to damage.

As a basic rule, save important content to a disc as backup.

■ The HDD is a device that is not built to withstand vibration/shock or dust

Depending on the setup environment and handling of the HDD some content may become damaged and play and recording may no longer be possible. Especially during operation, do not subject the unit to any vibration, shock, or remove the AC mains lead from the household mains socket. In the event of a power failure during recording or play, the content may be damaged.

■ The HDD is a temporary storage device

The HDD is not an everlasting storage device for recorded content. Use the HDD as a temporary storage place for one-off viewing, editing, or copying. It is recommended to save the recorded content on a disc or to keep the original data or CDs that they were copied from.

■ Immediately save (backup) all content as soon as you feel there may be a problem with the HDD

If there is an irregularity within the HDD, repetitive strange sounds or problems with picture (block noise, etc.) may result. Using the HDD in this condition may worsen the problem and in the worst case the HDD may no longer be usable. As soon as you notice this type of problem, copy all content to disc and request service. Recorded content (data) on a HDD that has become unusable is unrecoverable.

- When the unit is turned on or off, there may be an unexpected sound. This does not indicate a problem with this unit.

■ Setup precautions

- Do not place in an enclosed area where the rear cooling fan and the cooling vents on the side are covered up.
- Place the unit on a surface that is flat and not subject to vibration or impact.
- Do not place on anything that generates heat like a video cassette recorder, etc.
- Do not place in an area often subject to temperature changes.
- Place in an area where condensation does not occur. Condensation is a phenomenon where moisture forms on a cold surface when there is an extreme change in temperature. Condensation may cause internal damage to the unit.

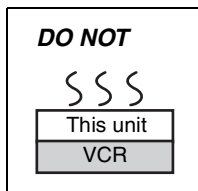

■ Conditions where condensation may occur

- When there is an extreme change in temperature (moving from a very hot location to a very cold location, or vice versa, or when subjected to an air conditioner or when cooled air directly impacts the unit). When the HDD (warms during operation) is subjected to cold air, condensation may form on the inside of the HDD and may cause damage to the HDD heads, etc.
- When there is high humidity or a lot of steam in the room.
- During the rainy season.

In the above situation, **without turning the unit on**, let the unit adjust to the room temperature and wait 2–3 hours until condensation is gone.

■ Cigarette smoke etc. causes malfunction or breakdown

The unit may breakdown if cigarette smoke or bug spray/vapor, etc. gets inside the unit.

■ While operating

- Do not move the unit or subject to vibration or impact. (The HDD may become damaged.)
 - Do not remove the AC mains lead from the household mains socket, or flip the power breaker switch.
- While the unit is on, the HDD is rotating at high speed. Sound or movement due to rotation is normal.

■ When moving the unit

- ① Turn the unit off. (Wait until "BYE" disappears from the display.)
- ② Remove the AC mains lead from the household mains socket.
- ③ Move only after the unit has come to a complete stop (approx. 2 minutes) in order to avoid subjecting to vibration and shock. (Even after turning the unit off, the HDD continues operating for a short time.)

■ HDD recording time remaining

This unit records using a VBR (Variable bit rate) data compression system to vary recorded data segments to match video data segments which may cause differences in the displayed amount of time and space remaining for recording.

If the remaining amount of time is insufficient, delete any unwanted titles to create enough space before you start recording. (Deleting a playlist will not increase the amount of time.)

■ Indemnity concerning recorded content

Panasonic does not accept any responsibility for damages directly or indirectly due to any type of problems that result in loss of recording or edited content (data), and does not guarantee any content if recording or editing does not work properly. Likewise, the above also applies in a case where any type of repair is made to the unit (including any other non-HDD related component).

Unit care

The precision parts in this unit are readily affected by the environment, especially temperature, humidity, and dust. Cigarette smoke also can cause malfunction or breakdown.

To clean this unit, wipe with a soft, dry cloth.

- Never use alcohol, paint thinner or benzine to clean this unit.
- Before using chemically treated cloth, carefully read the instructions that came with the cloth.

Observe the following points to ensure continued listening and viewing pleasure.

Dust and dirt may adhere to the unit's lens over time, making it impossible to record or play discs.

Use the **DVD lens cleaner** (not included) about once every year, depending on frequency of use and the operating environment. Carefully read the lens cleaner's instructions before use.

DVD lens cleaner: RP-CL720E

- This lens cleaner may not be for sale depending on the region.

DO NOT
Do not place the unit on amplifiers or equipment that may become hot.

The heat can damage the unit.

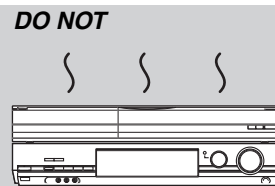

Note

Do not obstruct the rear panel's internal cooling fan.

Before moving the unit, ensure the disc tray is empty. Failure to do so will risk severely damaging the disc and the unit.

Remote control

Instructions for operations are generally described using the remote control.

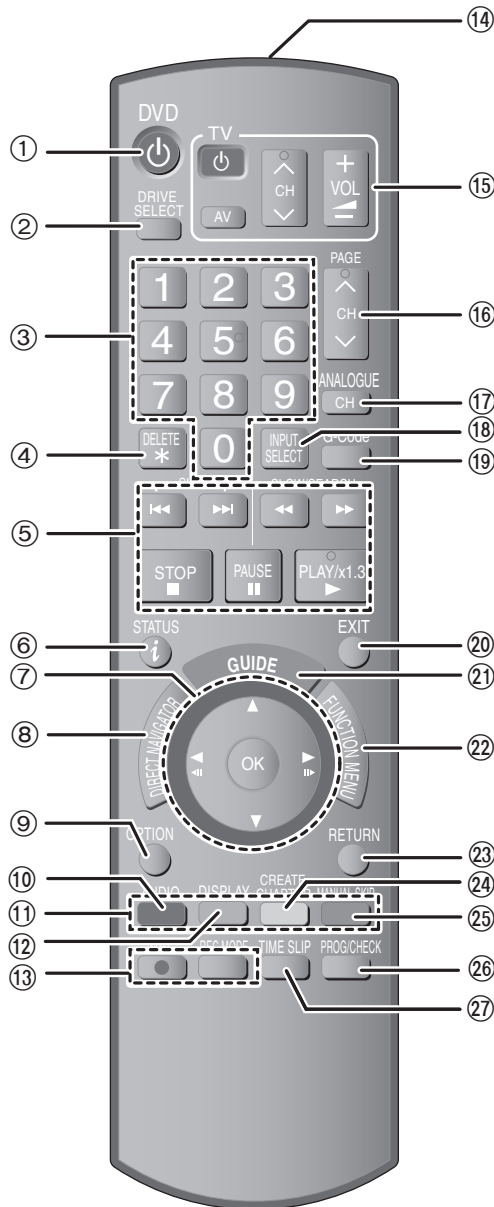

- ① Turn the unit on (⇒ 9)
- ② Select drive [HDD, DVD or SD (EX88)] (⇒ 16, 17, 32)
Drive changes each time you press [DRIVE SELECT].
- ③ Select channels and title numbers, etc./Enter numbers
- ④ To delete unnecessary recorded titles, still pictures or music (⇒ 19, 43)
- ⑤ Basic operations for recording and play
- ⑥ Show digital channel information (⇒ 15)/Programme information within TV Guide screen (⇒ 27)/Show status messages (⇒ 55)
- ⑦ Selection/OK, Frame-by-frame (⇒ 28)
- ⑧ Show DIRECT NAVIGATOR (⇒ 29, 38)
- ⑨ Show OPTION menu (⇒ 38)
This menu is used when playing or editing titles and still pictures, etc.
- ⑩ Select audio (Analogue broadcast only) (⇒ 28)
- ⑪ Colour buttons
 - for TV Guide operations (⇒ 27)
 - for switching the DIRECT NAVIGATOR screen (⇒ 29, 32, 34)
 - for switching Video/Playlists (⇒ 47)
 - for tuning settings (⇒ 59)
- ⑫ Show on-screen menu (⇒ 54)
Menu for disc playback and changing DVB multi audio etc.
- ⑬ Recording functions
 - [REC] Start recording (⇒ 17)
 - [REC MODE] Change recording mode (⇒ 17)
- ⑭ Transmit the remote control signal
- ⑮ Television operations (⇒ 67)
- ⑯ Channel select/Change pages in the TV Guide system (⇒ 17, 27)
- ⑰ Select analogue channel (⇒ 17)
- ⑱ Input select (AV1, AV2, AV3, AV4 or DV) (⇒ 23)
- ⑲ Show G-CODE screen (⇒ 24)
- ⑳ Exit the menu screen
- ㉑ Show the TV Guide screen (⇒ 18)
- ㉒ Show FUNCTION MENU window (⇒ 35)
By using the FUNCTION MENU window you may access the main functions (Playback, Recording, etc.) quickly and easily.
- ㉓ Return to previous screen
- ㉔ Create chapter (⇒ 28)
- ㉕ Skip approx. 1 minute forward (⇒ 28)
- ㉖ Show Timer Recording screen (⇒ 24)
- ㉗ Skip the specified time (⇒ 28)

Main unit

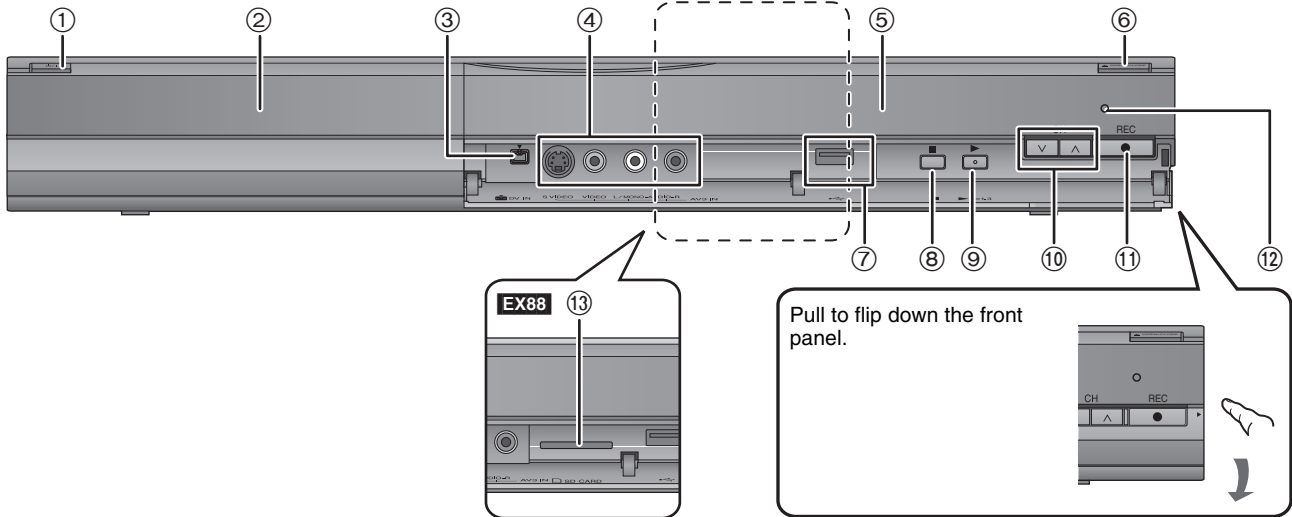

① **Standby/on switch (⏻/⏻)** (⇒ 9)

Press to switch the unit from on to standby mode or vice versa. In standby mode, the unit is still consuming a small amount of power.

② **Disc tray** (⇒ 14)

③ **Connection for digital video (DV) camcorder** (⇒ 23)

④ **Connection for VCR, camcorder etc.** (⇒ 23)

⑤ **Display** (⇒ below)

⑥ **Open/close disc tray** (⇒ 14)

⑦ **USB port** (⇒ 14)

⑧ **Stop** (⇒ 17, 28)

⑨ **Start play** (⇒ 16)

⑩ **Channel select** (⇒ 17)

⑪ **Start recording** (⇒ 17)/Specify a time to stop recording (⇒ 17)

⑫ **Remote control signal sensor**

⑬ **EX88 SD card slot** (⇒ 14)

Rear panel terminals (⇒ 8, 68, 69, 70, 71)

The unit's display

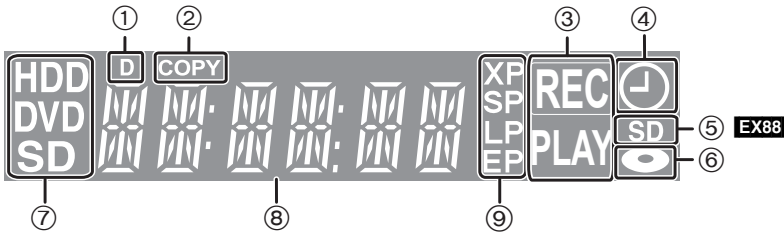

① **Digital broadcast indicator**

Lights when the unit is receiving digital broadcast or TV Guide data.

② **Copying indicator**

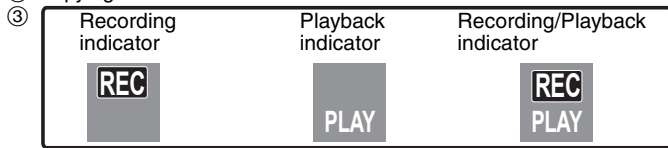

④ **Timer recording indicator**

⑤ **EX88 SD card slot indicator**

⑥ **Disc indicator**

⑦ **Drive [HDD, DVD or SD (EX88)] indicator**

⑧ **Main display section indicator**

⑨ **Recording mode indicator**

STEP 1 Connection

- Before connection, turn off all equipment and read the appropriate operating instructions.
- Refer to “Additional connections” (⇒ 68) for connection using other terminals and connection with other equipment.

When the unit is not to be used for a long time

To save power, unplug it from the household mains socket. This unit consumes a small amount of power, even when it is turned off [approx. 2 W (Power Save mode)]

When “Power Save” is set to “On”, the “Quick Start” function does not work.

Connecting to a television with 21-pin Scart terminal

You can also connect with the AV1 terminal on this unit using the 21-pin Scart cable. If your television is equipped with RGB input capability, by connecting with a fully wired 21-pin Scart cable you can see video using RGB output on this unit.

Required setting
“AV1 Output” in the Setup menu (⇒ 64)

Connecting a television

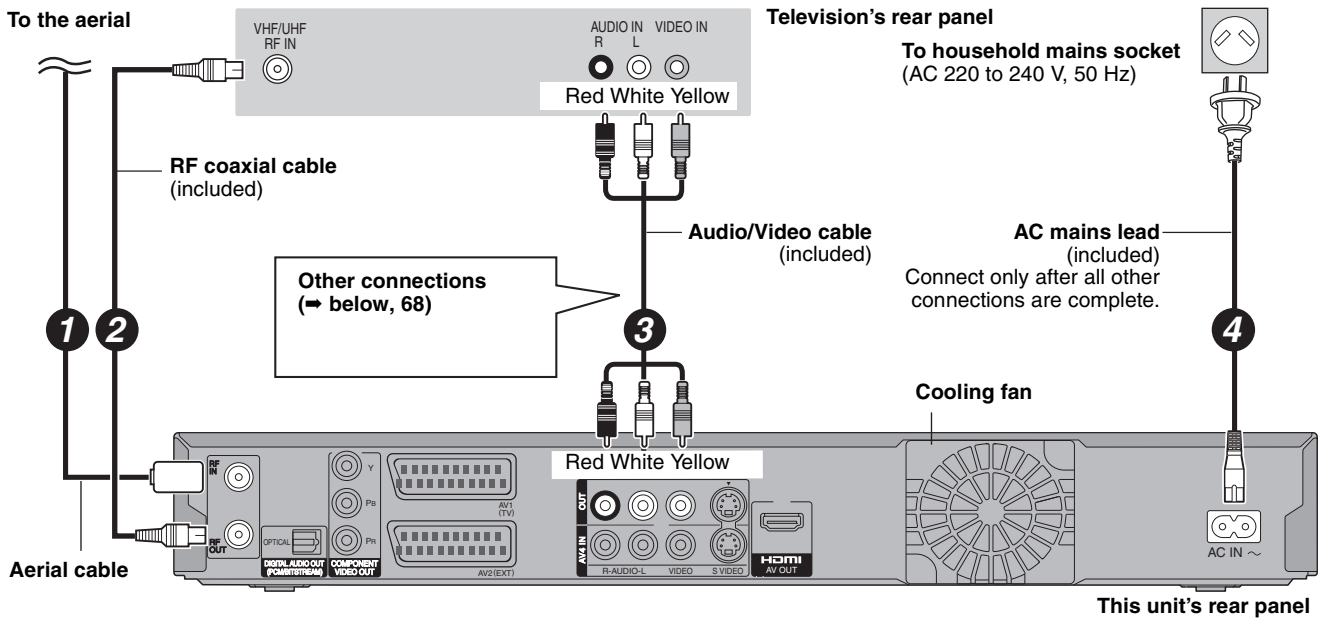

You can enjoy high-quality picture by changing the connection between this unit and your TV as follows.

Connecting to a TV with an HDMI (High Definition Multimedia Interface) cable

When connected to an HDMI compatible unit, an uncompressed digital audio and video signal is transmitted. You can enjoy high quality, digital video and audio with just one cord. When connecting to an HDMI-compatible HDTV (High Definition Television), the output can be switched to 1080p, 1080i or 720p HD video.

- This unit incorporates HDMI™ (V.1.3 with Deep Colour) technology.
- Video sources converted to 1920×1080 resolution, while of high quality, will exhibit somewhat lower subjective image resolution than true, native 1080p full-HD sources. See dealer for details.
- Please use High Speed HDMI Cables that have the HDMI logo (as shown on the cover).
- When outputting 1080p signal, please use HDMI Cables 5.0 meters or less.

Regarding VIERA Link “HDAVI Control™” function

When connecting with a Panasonic TV (VIERA) or a receiver equipped with the “HDAVI Control” function, linked operations would be possible. [⇒ 36, Linked operations with the TV (VIERA Link “HDAVI Control™”)]

- Non-HDMI-compliant cables cannot be utilised.
- It is recommended that you use Panasonic’s HDMI cable.

Recommended part number:

RP-CDHG10 (1.0 m), RP-CDHG15 (1.5 m), RP-CDHG20 (2.0 m), RP-CDHG30 (3.0 m), RP-CDHG50 (5.0 m), etc.

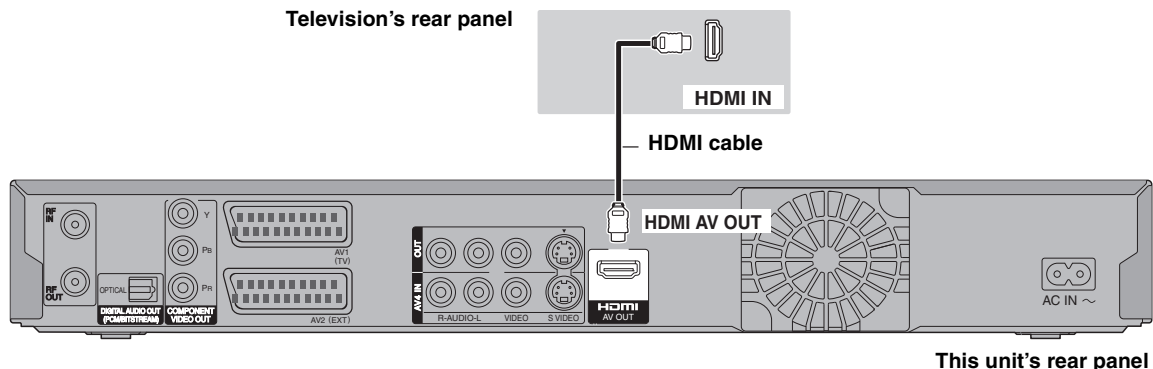

Required setting

Set “Digital Audio Output” to “HDMI and Optical” (⇒ 64). (The default setting is “HDMI and Optical”.)

Note

- If you are connecting to a TV that is only compatible with 2 channel audio output, audio with 3 channels or more will be down mixed (⇒ 84) and output as 2 channels, even if connecting with an HDMI cable. (Some discs cannot be down mixed.)
- You cannot connect this unit to DVI devices that are incompatible with HDCP.
- For units compatible with HDCP (High-Bandwidth Digital Content Protection) copyright protection that are equipped with a digital DVI input terminal (PC monitors, etc.): Depending on the unit, images may not display properly or at all when connecting with a DVI/HDMI switching cable. (Audio cannot be output.)

STEP 2 Channel reception settings and TV aspect settings

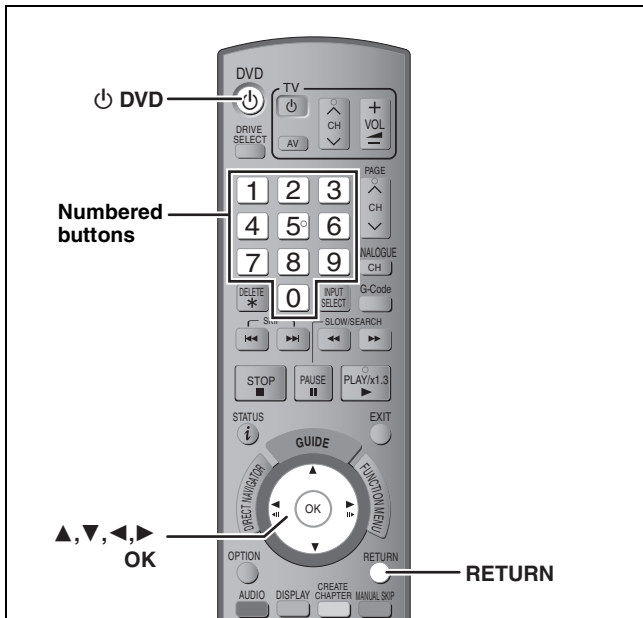

1 Turn on the television and select the appropriate AV input to suit the connections to this unit.

2 Press [DVD] to turn the unit on.

DVB Auto-Setup starts. The unit will search for the terrestrial digital channels. This takes about 5 minutes.

- Terrestrial digital channels are stored into logical channels numbers.
- Analogue channels are preset at the time of shipping. If you would like to add new TV channels, set them manually (⇒ 60).

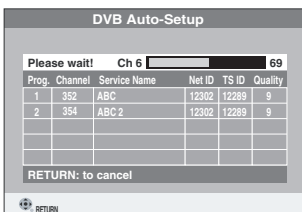

DVB Auto-Setup is complete when Region Selection screen appears.

The time information for your region can be obtained.

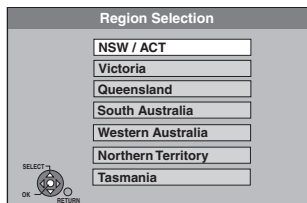

- If the clock setting screen is displayed (⇒ right).

3 Press [▲, ▼] to select your region and press [OK].

Quick Start setting screen appears.

Quick Start (⇒ 65)

If you select "On",

- the unit starts recording in about 1 second* after you press [● REC] while the unit is turned on.
- the unit displays the TV Guide screen in less than 1 second after you press [GUIDE] while the unit is turned off.

* Only when recording to the HDD or DVD-RAM.

4 Press [▲, ▼] to select "On" or "Off" and press [OK].

TV aspect setting screen appears.

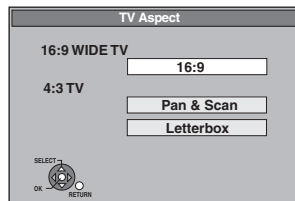

5 Press [▲, ▼] to select the TV aspect and press [OK].

- **16:9:**
When connected to a 16:9 widescreen television
- **Pan & Scan:**
When connected to a 4:3 aspect television, side picture is trimmed for 16:9 picture (⇒ 84).
- **Letterbox:**
When connected to a 4:3 aspect television. 16:9 picture is shown in the letterbox style (⇒ 84).



To stop partway

Press [RETURN].

When clock setting screen is displayed

In step 2, if the clock setting screen appears on the television, set the clock manually.

This is a 24-hour clock.

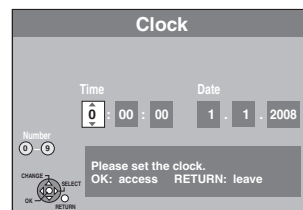

- 1 Press [◀, ▶] to select the item you want to change and press [▲, ▼] to change the setting. The items change as follows:
Hour ↔ Minute ↔ Second ↔ Day ↔ Month ↔ Year
- 2 Press [OK] when you have finished the settings.





- You can also use the numbered buttons for setting.

Quick Start setting screen appears. (⇒ Go to step 4)

- To confirm that stations have been tuned correctly (⇒ 59)
- To restart set up (⇒ 59)

HDD and discs you can use for recording and play

(○: Possible, -: Impossible)

Disc type Standard symbol	Logo	Data that can be recorded and played	Rewritable	Play on other players*1	Recording 16:9 aspect picture*2	Recording both M 1 and M 2 for bilingual broadcasts*2	Copy-once recording (CPRM)
Hard disk drive (HDD) HDD	—	Video Still picture Music	○	—	○	○	○
DVD-RAM RAM		Video Still picture	○	○	○	○	○ CPRM (⇒ 84) compatible discs only.
DVD-R -R before finalisation DVD-V after finalisation		Video	—	○	○	—*3 (Either one)	—
DVD-R DL*4 -R DL before finalisation DVD-V after finalisation		Video	—	○	○	—*3 (Either one)	—
DVD-RW -RW(V) before finalisation DVD-V after finalisation		Video	○	○	○	—*3 (Either one)	—
+R +R before finalisation DVD-V after finalisation	—	Video	—	○	— (4:3 aspect)	—*3 (Either one)	—
+R DL*4 +R DL before finalisation DVD-V after finalisation	—	Video	—	○	— (4:3 aspect)	—*3 (Either one)	—
+RW +RW	—	Video	○	○	— (4:3 aspect)	—*3 (Either one)	—

- *1 **-R -R DL -RW(V) +R +R DL**
Finalisation needed for playback on other equipment (⇒ 58).
RAM can be played back on Panasonic DVD recorders and DVD-RAM compatible DVD players.
-R DL, **+R DL** or **+RW** can be played back only on equipment compatible with these discs.
- *2 For further information (⇒ 20, Important notes for recording)
- *3 The audio selected in “Bilingual Audio Selection” (⇒ 62) is recorded.
- *4 **-R DL +R DL** You cannot directly record to these discs (⇒ right).
- **RAM -RW(V) +R +R DL +RW** To use a new disc, formatting is necessary (⇒ 57).
 - **+RW** If the disc failed to play on other equipment, we recommend you create top menu (⇒ 58).
 - Use of Panasonic discs is recommended.
For available recording times for different discs under different recording modes, see “Recording modes and approximate recording times” (⇒ 21).
 - Formatting and/or recording/initializing constraints may prevent you from playing or recording certain discs.
 - Please see specifications (⇒ 83) for compatible disc versions and recording speeds.

■ Recording format

This unit records video in the following formats.

DVD Video Recording format **HDD RAM**

This is a recording method which allows you to record and edit television broadcasts and so on.

- You can delete unwanted parts of a title, create playlists, etc.
- The broadcasts that allow “One time only recording” can be recorded to a CPRM compatible disc.

DVD-Video format **-R -R DL -RW(V)**

This recording method is the same as commercially available DVD-Video.

- The broadcasts that allow “One time only recording” cannot be recorded even if using a CPRM compatible disc.
- After finalising the disc, you can play the disc on DVD players and other equipment.

+VR (+R/+RW Video Recording) format **+R +R DL +RW**

This is a method for recording moving pictures to +R/+RW discs. You can playback such discs recorded in this method in a similar way as contents recorded in the DVD-Video format.

- The broadcasts that allow “One time only recording” cannot be recorded.
- After finalising the disc or creating the top menu, you can play the disc on DVD players and other equipment.

Note

- When “Rec for High Speed Copy” is set to “On”, the restrictions on secondary audio recording are also applied to DVD-RAM. Turn this setting “Off” if high speed copy to **-R -R DL -RW(V) +R +R DL +RW** is not necessary (The default setting is “On”. ⇒ 61).
- +R discs recorded with this unit and +R discs recorded with another Panasonic DVD Recorder may be incompatible. However, discs that are finalised are compatible and can be played.
- This unit cannot record NTSC signals to discs that already have PAL signal recordings. (However, both types of programmes can be recorded onto the HDD.)
- You may not be able to record depending on the condition of the discs and you may not be able to play due to the condition of the recording.

You cannot directly record to a DVD-R DL and +R DL disc on this unit.





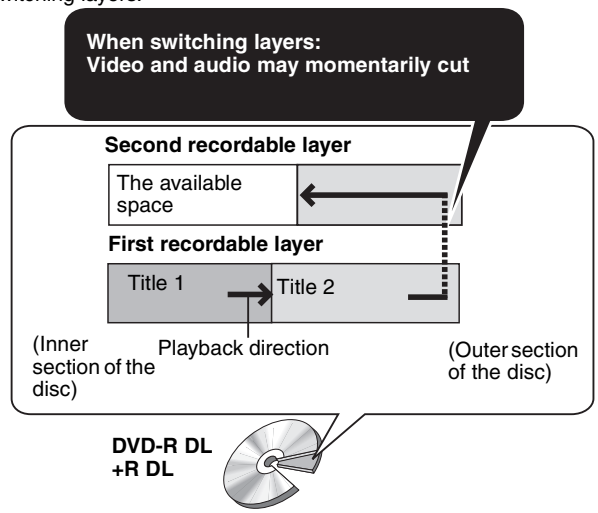

Record to the HDD and then copy to the disc.

When playing DVD-R DL (Dual Layer, single-sided) and +R DL (Double Layer, single-sided)

DVD-R DL (Dual Layer, single-sided) and +R DL (Double Layer, single-sided) discs have two writable layers on one side. If there is not enough space on the first layer to record a programme, the remainder is recorded on the second layer. When playing a title recorded on both layers, the unit automatically switches between layers and plays the title in the same way as a normal programme. However, video and audio may momentarily cut out when the unit is switching layers.



Play-only discs

Disc type	Logo	Standard symbol	Uses
DVD-Video		DVD-V	High quality movie and music discs
DVD-RW (DVD Video Recording format)		-RW(VR)	DVD-RW video recorded on another DVD recorder <ul style="list-style-type: none"> You can play programmes that allow One time only recording if they have been recorded onto a CPRM compatible disc. By formatting (⇒ 57) the disc, you can record onto it in DVD-Video format. It may be necessary to finalise the disc on the equipment used for recording.
DVD-R DVD-R DL	 	DivX	<ul style="list-style-type: none"> DVD-R and DVD-R DL with video recorded in DivX
CD		CD	Recorded audio and music (including CD-R/RW*)
	—	DivX, MP3, JPEG	<ul style="list-style-type: none"> CD-R and CD-RW with video recorded in DivX CD-R and CD-RW with music recorded in MP3 CD-R and CD-RW with still pictures recorded in JPEG
Video CD		VCD	<ul style="list-style-type: none"> Recorded music and video (including CD-R/RW*)

* Close the session after recording. Play may be impossible on some discs due to the condition of the recording.

- The producer of the disc can control how discs are played. So you may not always be able to control play as described in these operating instructions. Read the disc's instructions carefully.
- Operation and sound quality of CDs that do not conform to CD-DA specifications (copy control CDs, etc.) cannot be guaranteed.

Discs that cannot be played

- 2.6 and 5.2 GB DVD-RAM, 12 cm
- 3.95 and 4.7 GB DVD-R for Authoring
- DVD-R, DVD-R DL, DVD-RW, +R, +R DL recorded on another unit and not finalised (⇒ 84).
- Discs recorded with AVCHD format.
- DVD-Video with a region number other than "4" or "ALL"
- DVD-Audio
- Blu-ray, HD DVD
- DVD-ROM, +R (8 cm), CD-ROM, CDV, CD-G, Photo CD, CVD, SVCD, SACD, MV-Disc, PD, etc.

Types of disc or title recorded on HDD for the type of connected TV

When you use the discs recorded either PAL or NTSC, or playback a title recorded on HDD using PAL or NTSC, refer to this table.

(○: Possible to view, —: Impossible to view)

TV type	Disc/Titles recorded on HDD	Yes/No
Multi-system TV	PAL	○
	NTSC	○
PAL TV	PAL	○
	NTSC	○*1 (PAL60)
NTSC TV	PAL	—
	NTSC	○*2

*1 If your television is not equipped to handle PAL 525/60 signals the picture will not be shown correctly.

*2 Select "NTSC" in "TV System" (⇒ 64).

- When playing back a title recorded on the HDD, ensure that you match the "TV System" setting to the title (PAL or NTSC) (⇒ 64).

USB memories you can use on this unit

Compatible USB memories	USB memories which are defined as USB mass storage class, and digital cameras that use PTP protocol: –USB memories that support USB 1.0/1.1 and USB 2.0 Full Speed/High Speed. EX78 USB memories for USB 2.0 High Speed work as USB 2.0 Full Speed. ●USB memories of up to 128 GB can be used. ●USB memories that support bulk only transfer. CBI (Control/Bulk/Interrupt) is not supported. ●Digital Cameras which require additional programme installation when connected to a PC are not supported. ●MTP (Media Transport Protocol) device is not supported. ●A multi-port USB card reader is not supported.		
Format	FAT16 and FAT32 file systems are supported. ●UDF/NTFS/exFAT file system is not supported. ●Depending on the sector size, some files may not work. ●Only the first partition on USB memories with multi-partition is supported.		
Indicated in these instructions by	USB		
Data that can be played or copied (○: Possible, -: Impossible)			
File format	DivX	MP3	Still pictures (JPEG)
Playing	○	○	○
Copying to HDD	-	○	○
Instructions	You can play DivX files recorded with a computer onto the USB memory (➡ 30).	You can play and copy to HDD MP3 files recorded with a computer onto the USB memory (➡ 31, 52).	You can play and copy to HDD or DVD-RAM still pictures recorded with a computer onto the USB memory (➡ 32, 50).

- Despite meeting the conditions mentioned above, there may be USB memories that cannot be used for this unit.
- EX88** If a Panasonic digital video camera with HDD is connected to this unit's USB port, you can copy the SD Video shot with the camera to this unit's HDD or DVD-RAM.

Note

- This unit's USB port does not support bus-powered USB device.

Cards you can use on this unit **EX88**

Type	SD Memory Card* (from 8 MB to 2 GB) SDHC Memory Card (from 4 GB to 16 GB) MultiMediaCard * Including miniSD Card and microSD Card The card types mentioned above will be referred to as "SD card" in these operating instructions.
Indicated in these instructions by	SD
Data that can be recorded and played	Still pictures (JPEG) Video (SD Video)
Instructions	You can insert directly into the SD card slot. * A miniSD Card and a microSD Card must be used with the adaptor that comes with the card. ●You can play and copy still pictures taken on a digital camera etc. (➡ 32, 50). ●SD Video shot with a Panasonic SD Video camera, etc. can be copied to the HDD or DVD-RAM. (➡ 49) ●SD Video cannot be played directly from the SD card.

Suitable SD cards

- When using SD cards 4 GB or larger, only SD cards that display the SDHC logo can be used.
- Useable memory is slightly less than the card capacity.
- Please confirm the latest information on the following website.
<http://panasonic.co.jp/pavc/global/cs>
 (This site is in English only.)
- If the SD card is formatted on other equipment, the time necessary for recording may be longer. Also, if the SD card is formatted on a PC, you may not be able to use it on this unit. In these cases, format the card on this unit (➡ 57, 84).
- This unit is compatible with SD Memory Cards that meet SD Card Specifications FAT12 and FAT16 formats, as well as SDHC Memory Cards in FAT32 format.
- SDHC Memory Cards used for recording with this unit can only be used with other SDHC Memory Card-compatible equipment. SDHC Memory Cards cannot be used with equipment that is only compatible with SD Memory Cards.
- We recommend using a Panasonic SD card.
- This unit cannot play AVCHD format motion pictures on an SD card.
- Keep the Memory Card out of reach of children to prevent swallowing.

Structure of folders

***: Numbers
 XXX: Letters

Card

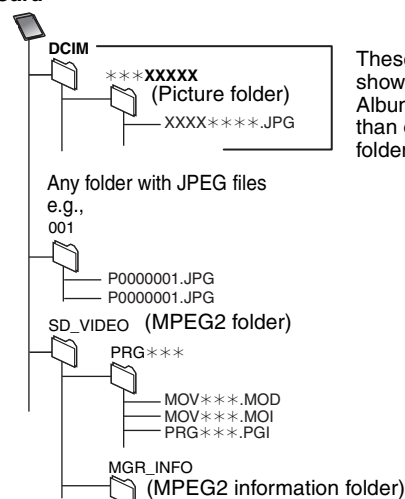

Regarding DivX files, MP3 files and still pictures (JPEG)

Instructions/notes regarding SD cards and SD drive are applicable to the DMR-EX88 model only.

DivX

Playable media	R RDL CD USB
File format	DivX <ul style="list-style-type: none"> Files must have the extension ".DIVX", ".divx", ".AVI" or ".avi". 
Number of folders	Maximum number of folders recognizable: 300 folders (including the root folder)
Number of files	Maximum number of files recognizable*1: 200 files
Support version	Plays all versions of DivX video (including DivX 6) with standard playback of DivX media files. Certified to the DivX Home Theater Profile. Video - Number of stream: Up to 1 - Codec: DIV3, DIV4, DIVX, DV50 - Picture size: 32 x 32 to 720 x 576 - FPS (Frame Per Second): Up to 30 fps Audio - Number of stream: Up to 8 - Format: MP3, MPEG, AC3 - Multi channel: AC3 is possible. MPEG multi is 2 ch conversion.

MP3

Playable media	HDD CD USB
File format	MP3 <ul style="list-style-type: none"> Files must have the extension ".mp3" or ".MP3".
Number of folders (groups)	Maximum number of folders (groups) recognizable: 300 folders (groups) (including the root folder)
Number of files (tracks)	Maximum number of files (tracks) recognizable*1: 3000 files (tracks)
Bit rates	32 kbps to 320 kbps
Sampling frequency	16 kHz/22.05 kHz/24 kHz/32 kHz/44.1kHz/48 kHz
ID3 tags	compatible (HDD USB)

*1 If there is a large amount of still picture data etc. within a MP3 file, play may not be possible.

Still pictures (JPEG*2)

Playable media	HDD RAM CD USB SD
File format	File format: JPEG <ul style="list-style-type: none"> Files must have the extension ".jpg" or ".JPG".
Number of pixels	Between 34×34 and 6144×4096 (Sub sampling is 4:2:2 or 4:2:0)
Number of folders*3	CD USB Maximum number of folders recognizable: 300 folders (including the root folder) HDD RAM SD This unit can handle a maximum of 300 folders
Number of files*3	CD USB Maximum number of files recognizable*1: 3000 files HDD RAM SD This unit can handle a maximum of 3000 files
MOTION JPEG	not supported

*1 Total number of recognizable file including MP3, JPEG, DivX and other types of files is 4000.

*2 It may take a few moments for still pictures to display.

*3 When there are many files and/or folders, some files may not display or be playable.

R RDL CD

- Compatible formats: ISO9660 level 1 or 2 (except for extended formats) and Joliet
- This unit is compatible with multi-session but reading or play of the disc may take time if there are a lot of sessions.
- Operation may take time to complete when there are many files (tracks) and/or folders (groups) and some files (tracks) may not display or be playable.
- English alphabet and Arabic numerals are displayed correctly. Other characters may not be displayed correctly.
- The display order on this unit may differ from how the order is displayed on a computer.
- Depending on how you create the disc (writing software), files (tracks) and folders (groups) may not play in the order you numbered them.
- This unit is not compatible with packet-write format.
- Depending on the recording conditions, the disc may not play.

HDD RAM SD

- Compatible formats: DCF*4 compliant (Content recorded on a digital camera, etc.)

*4 Design rule for Camera File system: unified standard established by Japan Electronics and Information Technology Industries Association (JEITA).

Structure of folders displayed by this unit

You can play MP3 and still pictures (JPEG) on this unit by making folders as shown below. However depending on the method of writing data (writing software), play may not be in the order you numbered the folders.

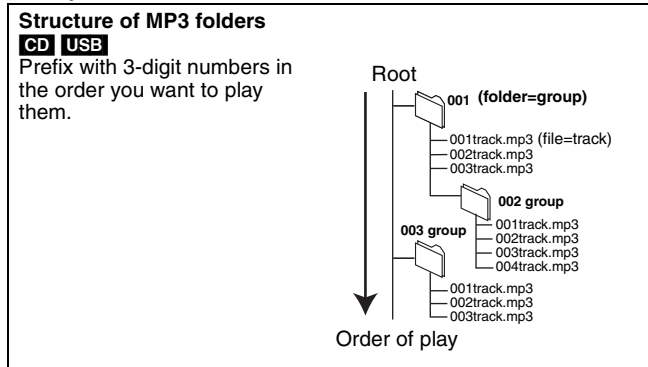

Structures of still picture folders

CD USB

Files inside a folder are displayed in the order they were updated or taken.

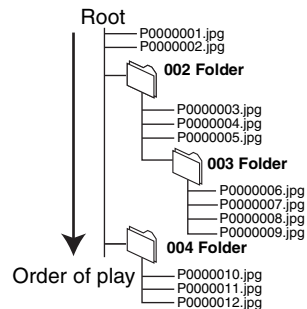

RAM

The following  can be displayed on this unit.

***: Numbers XXX: Letters

*1 Still pictures on the root folder can also be displayed.

*2 Folders can be created on other equipment. However, these folders cannot be selected as a copying destination.

*3 If a folder name or file name has been input using other equipment, the name may not be displayed properly or you may not be able to play or edit the data.

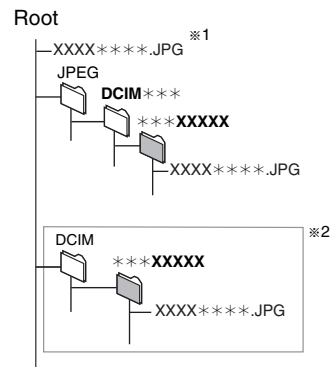

Inserting discs

① Press [▲ OPEN/CLOSE] to open the tray.

■ Cartridge disc

Insert label-up.

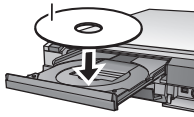

Insert label-up with the arrow facing in.

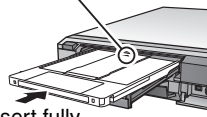

Insert fully.

② Press [▲ OPEN/CLOSE] to close the tray.

Automatic drive select function

RAM [Only for discs with the write-protect tab on the cartridge set to "PROTECT" (⇒ 56, Cartridge-protection)]

DVD-V VCD CD

- If the unit is recording to the HDD or stopped, it automatically switches to the DVD drive when a disc is inserted.
- If you eject a disc and close the disc tray, the HDD drive is automatically selected.

Note

- When using 8 cm DVD-RAM, or 8 cm DVD-R, remove the disc from the cartridge.
- **RAM** It is not possible to record or play continuously from one side of a double sided disc to the other. You will need to eject the disc and turn it over.
- **RAM** When using cartridge discs with the write-protect tab in the protect position (⇒ 56), play automatically starts when inserted in the unit.

Inserting, removing the USB memory

Inserting the USB memory

- Before inserting any USB memory to this unit, ensure that the data stored therein has been backed up.
- Check the orientation of the USB connector and insert it straight in.
- Insert a USB device while the unit is stopped, so the "USB device" screen is displayed. Select an item and press [OK] to switch to the USB-related operations (⇒ 30, 50).

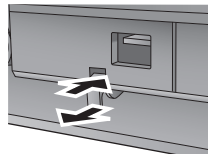

Removing the USB memory

- Complete all USB-related operations and pull the USB memory straight out.
- If a USB memory being accessed is pulled out, then the data may be damaged.

Inserting, removing the SD card EX88

When the card indicator ("SD") on the unit's display is flashing, the card is being read from or written to. Do not turn off the unit or remove the card. Such action may result in malfunction or loss of the card's contents.

- Inserting foreign objects can cause a malfunction.

Inserting the card

Press on the centre of the card until it clicks into place.

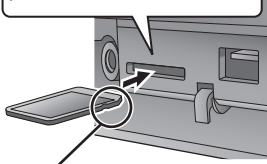

Insert the card label up with the cut-off corner on the right.

If you are using a e.g., miniSD
microSD card, insert it into the adaptor that comes with the card. Insert and remove this adaptor from the unit.



Removing the card

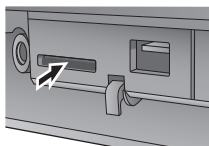

- ① Press on the centre of the card.
- ② Pull it straight out.

Automatic drive select function

- If you insert an SD card while the unit is stopped, the "SD Card" screen is displayed. Select an item and press [OK] to switch to the SD drive (⇒ 30, 50).
- If you remove an SD card, the HDD drive is automatically selected.

Disc and card care

■ How to hold a disc or card

Do not touch the recorded surface or the terminal surface.

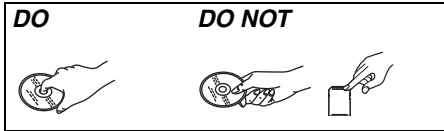

■ Concerning non-cartridge discs

Be careful about scratches and dirt.

■ If there is dirt or condensation on the disc

Wipe with a damp cloth and then wipe dry.



■ Handling precautions

- Do not attach labels or stickers to discs. (This may cause disc warping and un-balanced rotation, rendering it unusable.)
- Write on the label side of the disc only with a soft, oil-based felt pen. Do not use ballpoint pens or other hard writing implements.
- Do not use record cleaning sprays, benzene, thinner, static electricity prevention liquids or any other solvent.
- Do not use scratch-proof protectors or covers.
- Do not expose the terminals of the card to water, garbage or other strange things.
- Do not drop stack, or impact discs. Do not place objects on them.
- Do not use the following discs:
 - Discs with exposed adhesive from removed stickers or labels (rental discs, etc.).
 - Discs that are badly warped or cracked.
 - Irregularly shaped discs, such as heart shapes.

DO NOT

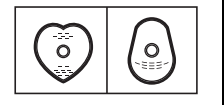

- Do not place in the following areas:
 - In direct sunlight.
 - In very dusty or humid areas.
 - Near a heater.
 - Locations susceptible to significant difference in temperature (condensation can occur).
 - Where static electricity or electromagnetic waves occur.
- To protect discs from scratches and dirt, return them to their cases or cartridges when you are not using them.

The manufacturer accepts no responsibility and offers no compensation for loss of recorded or edited material due to a problem with the unit or recordable media, and accepts no responsibility and offers no compensation for any subsequent damage caused by such loss.

Examples of causes of such losses are

- A disc recorded and edited with this unit is played in a DVD Recorder or computer disc drive manufactured by another company.
- A disc used as described above and then played again in this unit.
- A disc recorded and edited with a DVD Recorder or computer disc drive manufactured by another company is played in this unit.

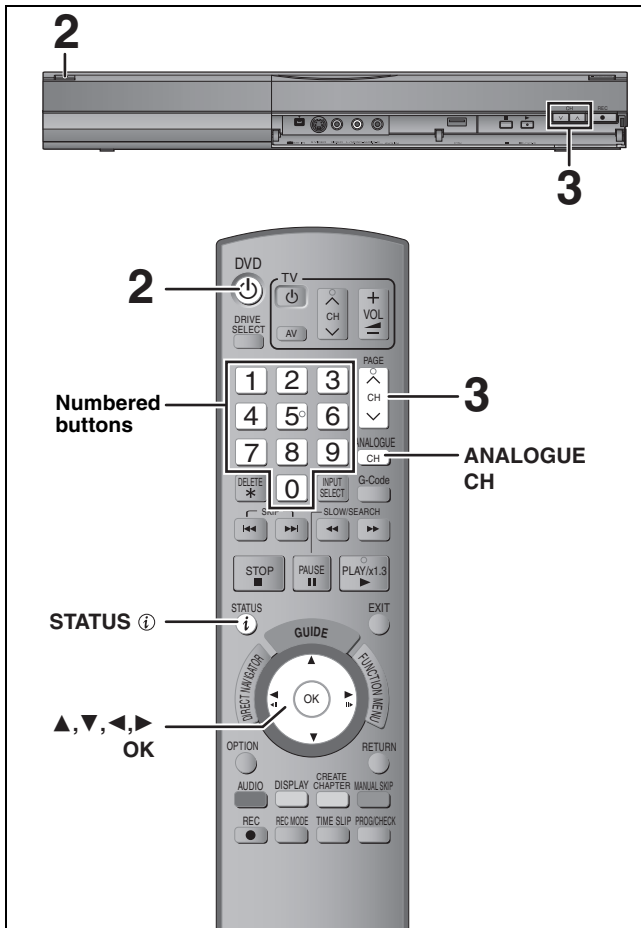

Select the channel

- 1** Turn on the television and select the appropriate AV input to suit the connections to this unit.
- 2** Press [DVD] to turn the unit on.
- 3** Press [▲ ▼ CH] to select the channel.

Everytime you change the station, digital channel information appears automatically (terrestrial digital channels only). Channels are displayed in the order of digital channels first, and then followed by analogue channels.

• Digital channel



You can also select the channel with the numbered buttons.

- e.g., 5: [0] → [0] → [5]
 15: [0] → [1] → [5]
 115: [1] → [1] → [5]

• Analogue channel



You can also select the channel with the following steps.

- 1 Press [ANALOGUE CH].
- 2 Press the numbered buttons to select the channel.

- e.g., 5: [0] → [5]
 15: [1] → [5]

Note (Digital broadcast only)

- This unit can receive Standard Definition (SD) broadcasts, but is unable to receive High Definition (HD) broadcasts. When High Definition (HD) programmes are broadcast, "Unable to decode HD" is displayed in the digital channel information (→ right).
- This unit can receive free cable television but it cannot receive paid services.

Digital channel information

While stopped

Press [STATUS ⓘ] to show the information screen.

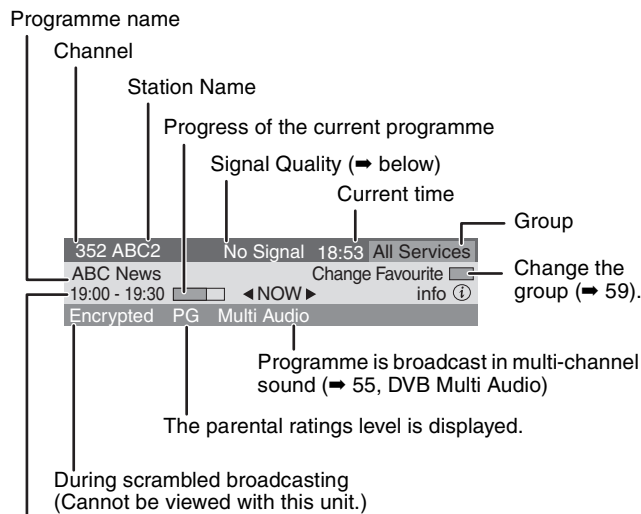

Broadcast time

To switch information of the current programme and the next programme
 Press [◀, ▶].

To show detailed information about the programme
 Press [STATUS ⓘ] again (only when "info ⓘ" is displayed).

To hide the information screen
 Press [STATUS ⓘ] once or twice.

Signal Quality

- No Signal: The digital broadcast signal is not being received.
- No Service: No broadcasts are currently available.

If "No Signal" is displayed:

- Adjust the position and direction of the aerial.
- Check that the current digital broadcast channel is correctly broadcasting.

Note

You can also select the other channel when the information screen is displayed by pressing [▲, ▼] and [OK].

■ If a software update is available, a notification is displayed on the digital channel information



Press the "Red" button to launch software update screen.

■ If New service message appears

When a new DVB channel is added, this unit will be informed automatically. Then the confirmation message appears. If you select "Yes" on the display, Auto-Setup starts (all channel settings and all created groups are deleted. The timer recording programmes are also cancelled.)

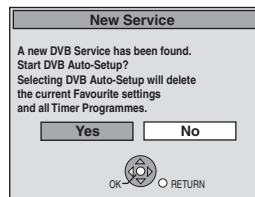

The display/hide setting can be changed (→ 63, New Service Message).

Refer to “Advanced playback” (⇒ 28) for detail information.

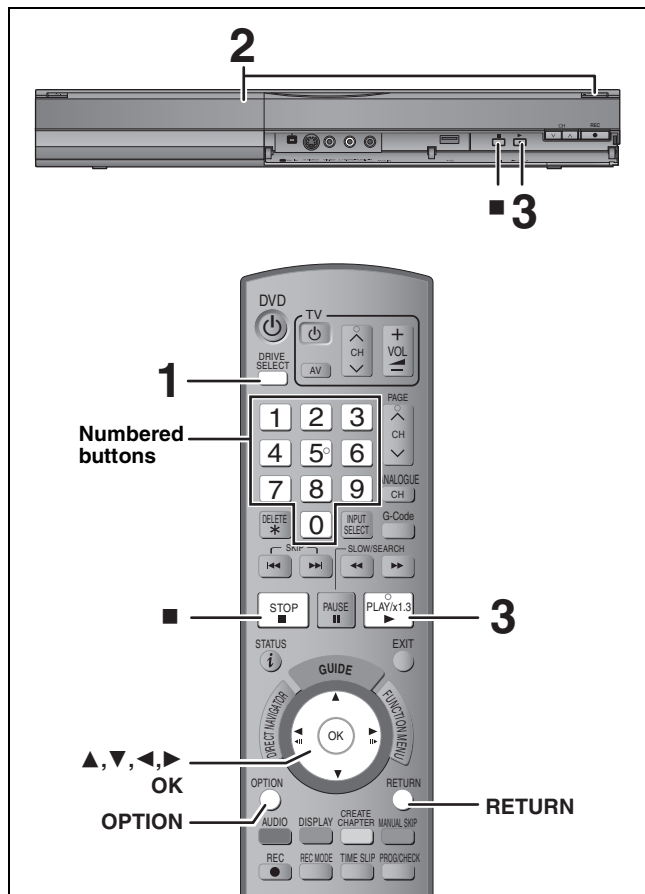

■ When a menu screen appears on the television

DVD-V

Press [▲, ▼, ◀, ▶] to select the item and press [OK].

- Some items can also be selected using the numbered buttons.
- If you are instructed to press the “ENTER” button by the menu screen or the disc’s instruction document, press [OK].

VCD

Press the numbered buttons to select the item.

e.g., 5: [0] ⇒ [5] 15: [1] ⇒ [5]

- To return to the menu screen

DVD-V

1 Press [OPTION].

2 Press [▲, ▼] to select “Top Menu” or “Menu” and press [OK].

VCD

Press [RETURN].

Note

Discs continue to rotate while menus are displayed. Press [■] when you have finished playback to protect the unit’s motor, your television screen and so on.

Preparation

- Turn on the television and select the appropriate AV input to suit the connections to this unit.
- Turn on this unit.

1 Press [DRIVE SELECT] to select the HDD or DVD drive.

The HDD or DVD indicator lights up on the unit’s display.

2 If you selected the DVD drive

Press [▲ OPEN/CLOSE] on the main unit to open the tray and insert a disc.

- Press the button again to close the tray.

3 Press [▶] (PLAY).

HDD RAM -R -R DL -RW(V) +R +R DL +RW -RW(VR)
Play starts from the most recently recorded title.

DVD-V VCD
Play starts from the point specified by the disc.

CD
Play starts from the beginning of the disc.

Menu operation for other type of contents

- DivX (⇒ 30)
- MP3 (⇒ 31)
- Still pictures (JPEG) (⇒ 32)
- Music on HDD (⇒ 34)
- Music CD (⇒ 34)

Note

- A disc or title with different “TV System” (⇒ 64) may not be able to playback while recording or on standby for the timer recording. You will be able to playback by changing the “TV System” settings in that case, but to prevent failure of the timer recording, change back the settings before the recording starts.
- Depending on the disc, it may take time for the menu screen, pictures, sound, etc. to start.
- The producer of the disc can control how discs are played. So you may not always be able to control play as described in these operating instructions. Read the disc’s instructions carefully.
- When playing back a title recorded on the HDD, ensure that you match the “TV System” setting to the recorded title (⇒ 64).

Recording television programmes

Refer to “Important notes for recording” (⇒ 20) and “Advanced recording” (⇒ 21) for detail information.

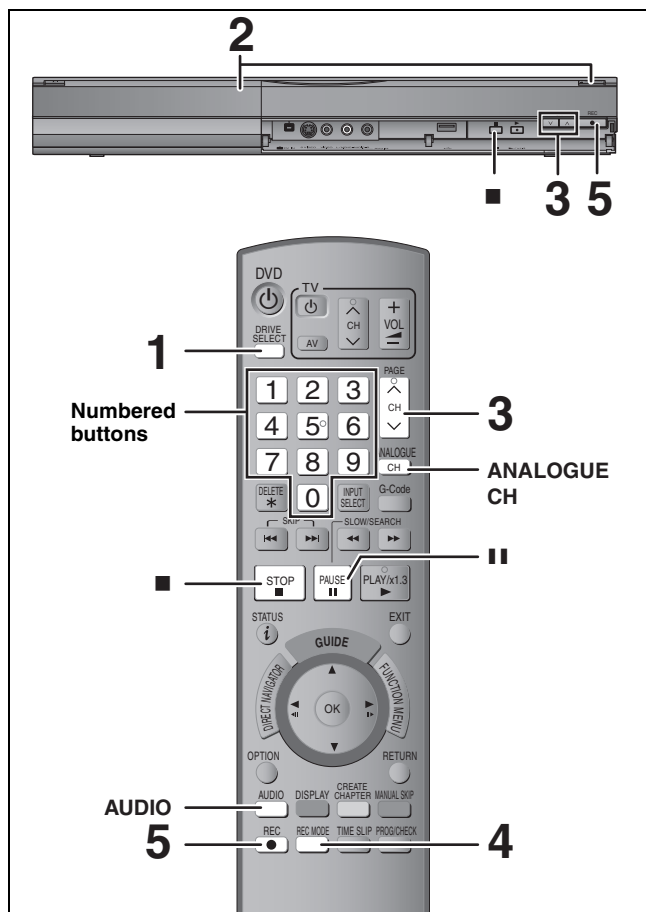

HDD **RAM** **-R** **-RW(V)** **+R** **+RW**

RAM **-RW(V)** **+R** **+RW**

- To use a new disc, formatting is necessary.
- When recording a digital radio broadcast or a digital broadcast that is not being received correctly, the digital channel information (⇒ 15) is also recorded and remains visible during playback.

Preparation

- Turn on the television and select the appropriate AV input to suit the connections to this unit.
- Turn on this unit.

- 1 Press [DRIVE SELECT] to select the HDD or DVD drive.**
The HDD or DVD indicator lights up on the unit's display.
- 2 If you selected the DVD drive Press [▲ OPEN/CLOSE] on the main unit to open the tray and insert a disc.**
• Press the button again to close the tray.
- 3 Press [▲ ▼ CH] to select the channel.**
Channels are displayed in the order of digital channels first, and then followed by analogue channels.
• **Digital channel**



You can also select the channel with the numbered buttons.

e.g., 5: [0] ⇒ [0] ⇒ [5]
15: [0] ⇒ [1] ⇒ [5]
115: [1] ⇒ [1] ⇒ [5]

• Analogue channel



You can also select the channel with the following steps.

- 1 Press [ANALOGUE CH].
- 2 Press the numbered buttons to select the channel.

e.g., 5: [0] ⇒ [5]
15: [1] ⇒ [5]

- 4 Press [REC MODE] to select the recording mode (XP, SP, LP or EP).**

- Recording modes and approximate recording times (⇒ 21)



Remaining time on the disc

- To record sound using LPCM (XP mode only): Set the “Audio Mode for XP Recording” to “LPCM” in the Setup menu (⇒ 62).

- 5 Press [● REC] to start recording.**



Recording will take place on open space on the HDD or on disc. Data will not be overwritten.

- You cannot change the channel or recording mode during recording.
- You can record while the unit is in standby for timer recording. However, once the time for the timer recording to begin is reached, any recording taking place will stop and the timer recording will begin.
- **HDD RAM** (Analogue broadcast only) When “Rec for High Speed Copy” is set to “Off” (⇒ 61), you can change the audio being received by pressing [AUDIO] during recording. (Does not affect the recording of audio.)

■ To pause recording

Press [II].

Press again to restart recording.
You can also press [● REC] to restart.
(Title is not split into separate titles.)

■ To stop recording

Press [■].

- From the start to the end of the recording is called one title.
- **-R** **-RW(V)** **+R** **+RW** It takes about 30 seconds for the unit to complete recording management information after recording finishes.

In order to play DVD-R, DVD-RW (DVD-Video format) and +R (recorded with this unit) on other DVD players, it is necessary to finalise them (⇒ 58).

- **USB** It is not possible to record on a USB memory.
- **SD** It is not possible to record on a card.

To specify a time to stop recording— One Touch Recording

HDD **RAM** **-R** **-RW(V)** **+R** **+RW**

During recording

Press [● REC] on the main unit to select the recording time.

- You can specify up to 4 hours later.
- The unit display changes as shown below.
OFF 0:30 → OFF 1:00 → OFF 1:30 → OFF 2:00
↑ Counter (cancel) ← OFF 4:00 ← OFF 3:00 ↓

- This does not work during timer recordings (⇒ 18, 24) or while using Flexible Recording (⇒ 22).
- The unit turns off automatically after the time to stop recording is reached.

To cancel

Press [● REC] on the main unit several times until the counter appears.

- The time to stop recording is cancelled; however, recording continues.

To stop recording

Press [■].

Refer to “Advanced timer recording” (⇒ 24–27) for detail information.

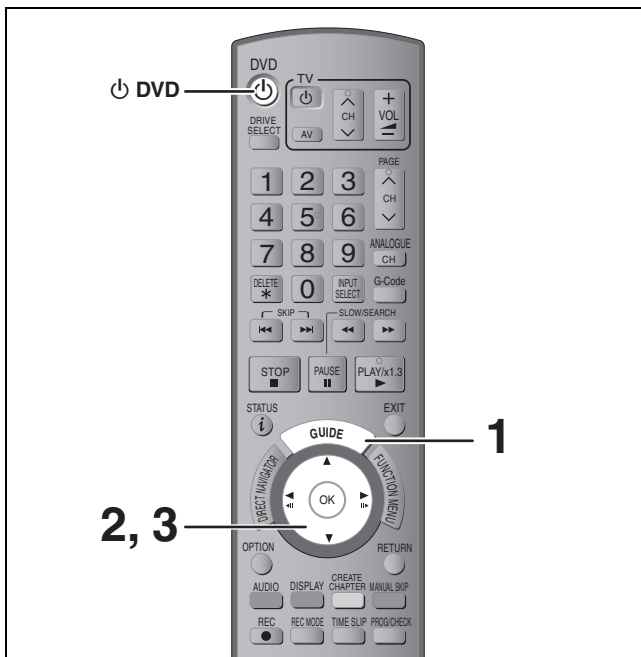

See also “Important notes for recording” (⇒ 20).

Depending on the type of disc used for recording or the type of broadcast, there may be restrictions on the title you are trying to record.

HDD **RAM** **-R** **-RW(V)** **+R** **+RW**

- You can enter up to 32 programmes up to a month in advance. (Each daily or weekly programme is counted as one programme.)

RAM **-RW(V)** **+R** **+RW**

- To use a new disc, formatting is necessary.

Preparation

- Turn on the television and select the appropriate video input to suit the connections to this unit.
- If recording to DVD, insert a disc that you can use for recording (⇒ 10, 14).
- Make sure that the clock settings are correct (⇒ 65).

Using the TV Guide system to make timer recordings (Digital broadcast only)

TV Guide system provides programme information only from the digital broadcasts station displayed on the television like a TV programme magazine.

This unit receives the programme information differently according to where you live.

Note

- TV Guide does not work if the clock is not set correctly.
- If the unit is disconnected from the AC mains, all programme data are not updated.
- TV Guide system of this unit does not support analogue broadcasts. Analogue broadcasts can be recorded manually or with the G-CODE system (⇒ 24).

1 Press [GUIDE].

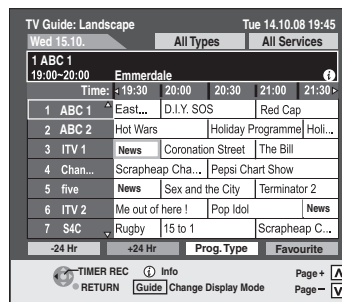

2 Press [▲, ▼, ◀, ▶] to select the future programme and press [OK].



- Confirm the programme (start and end time) by using a TV magazine, etc. and make corrections if necessary using [▲, ▼, ◀, ▶] (⇒ 24, right column, step 3).

3 Press [OK].

The timer programme is stored and the timer icon is displayed.



“⌚” lights on the unit’s display to indicate timer recording standby has been activated.

Repeat steps 2–3 to programme other recordings. Press [DVD] to turn the unit off.

Note

If “NTSC” has been selected for “TV System” (⇒ 64), the TV Guide system cannot be used.

■ To cancel a timer recording on the TV Guide screen

- Press [▲, ▼, ◀, ▶] to select the programme in the TV Guide and press [OK].
- Press [OK]. Confirmation screen appears.
- Press [◀] to select “Yes” and press [OK]. (“⌚” in the TV Guide disappears.)

Note

- The receipt of the TV Guide system data is only possible via the aerial input of this unit. The receipt of the TV Guide data via externally connected satellite receivers is not possible.

■ To cancel recording when recording has already begun (⇒ 25)

■ To release the unit from recording standby (⇒ 25)

■ Notes on timer recording (⇒ 25)

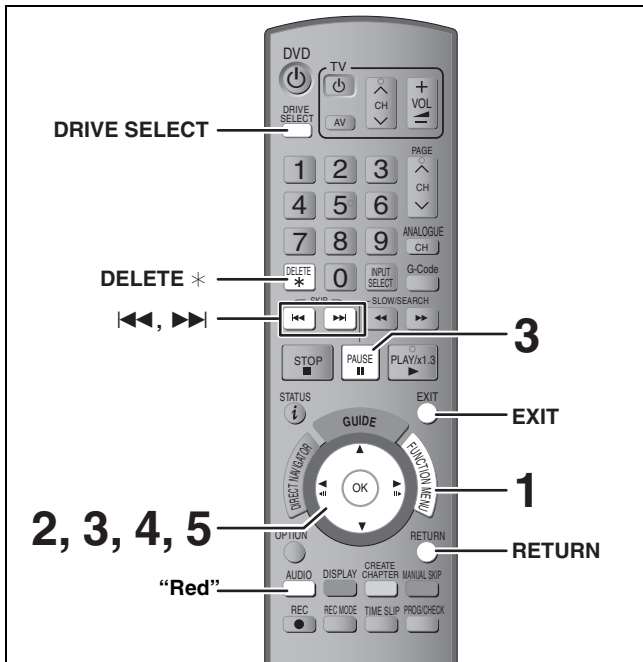

HDD RAM -R -R DL -RW(V) +R +R DL +RW
 (You cannot delete items on finalised discs.)

- A title cannot be restored once it is deleted. Make certain before proceeding.
- You cannot delete while recording or copying.

Preparation

- Press [DRIVE SELECT] to select the HDD or DVD drive.
- **RAM** Release protection (⇒ 56, Setting the protection).

■ Available disc space after deleting

- **HDD RAM** The space deleted becomes available for recording.

Available disc space increases after deleting any of these titles

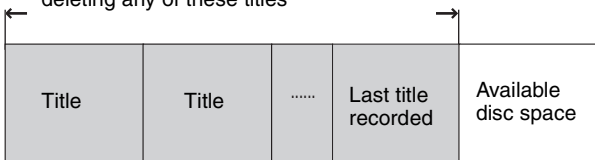

- **-RW(V) +RW** Available recording space increases only when the last recorded title is deleted.

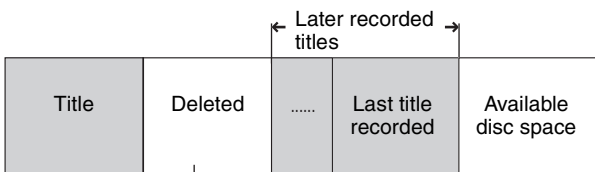
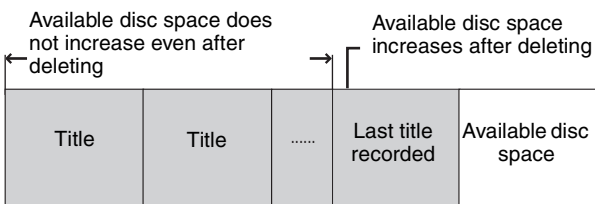

This space become available for recording after all the later recorded titles are deleted.

- **-R -R DL +R +R DL** Available space does not increase even after the contents are deleted.

Using the DELETE Navigator to delete

- 1 While stopped
Press [FUNCTION MENU].
- 2 Press [▲, ▼] to select “Delete” and press [OK].

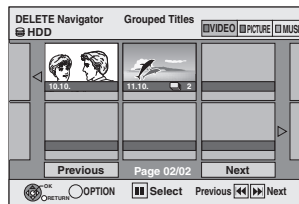

HDD RAM When “VIDEO” is not selected, press the “Red” button to select “VIDEO”.

- 3 Press [▲, ▼, ◀, ▶] to select the title and press [II].

A check mark is displayed. Repeat this step until you select all necessary items.

- Press [II] again to cancel.

To show other pages (Thumbnail Display only)

Press [◀, ▶] to show other pages.

You can confirm the titles, that you have selected using the option menu.

- Refer to option menu operations for the “Title View” (⇒ 38, step 4).

- 4 Press [OK].
- 5 Press [◀, ▶] to select “Delete” and press [OK].
The title is deleted.

To return to the previous screen



Press [RETURN].

To exit the screen

Press [EXIT].

Deleting during play

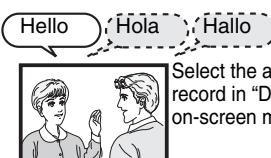
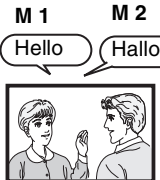
- 1 While playing
Press [DELETE *].
- 2 Press [◀, ▶] to select “Delete” and press [OK].
The title is deleted.

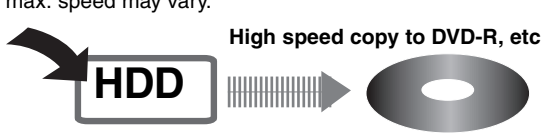
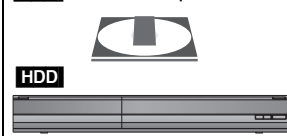
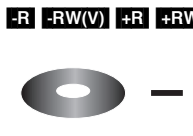
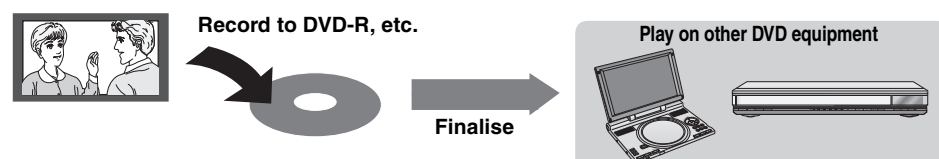
<p>Selecting Audio for Recording</p>	<p>Broadcast in multi-channel sound (Digital broadcast only): You can select the audio language when receiving audio in multi channel broadcast ["Multi Audio" appears at the bottom of digital channel information display (⇒ 15)]. However, audio cannot be switched after recording.</p>  <p>Select the audio that you want to record in "DVB Multi Audio" in the on-screen menu (⇒ 55).</p> <hr/> <p>Bilingual broadcasts (Analogue broadcast only): HDD RAM Both main and secondary audio can be recorded. You can change the audio during playback. (⇒ 28, Changing audio during play)</p> <p>However in the following cases, select whether to record the main or secondary audio:</p> <p>M 1 M 2 Hello Hello</p>  <p>–Recording sound in LPCM (⇒ 62, Audio Mode for XP Recording) –"Rec for High Speed Copy" is set to "On" (The default setting is "On". ⇒ 61)</p> <p>-R -RW(V) +R +RW Select the main or secondary audio before recording (⇒ 62, Bilingual Audio Selection)</p> <p>M 1 Hello</p>  <p>The selected audio only is recorded.</p> <hr/> <p>If you record from external equipment –Select "M 1" or "M 2" on the external equipment.</p>
<p>About the aspect when recording a programme</p>	<p>HDD RAM (When "Rec for High Speed Copy" is set to "On") -R -RW(V)</p> <p>If "Aspect for Recording" in the Setup menu is set to "Automatic" (The default setting is "Automatic" ⇒ 61), the programme will be recorded in the original aspect used when recording started (including when recording started at a commercial, etc.). If recorded with a different aspect, select the correct aspect ("16:9" or "4:3").</p> <p>However, in the following cases, programme will be recorded in 4:3.</p> <ul style="list-style-type: none"> • -R -RW(V) Programme recorded using "EP" or "FR" (recordings 5 hours or longer) recording modes will be recorded in 4:3 aspect. <p>HDD RAM (When "Rec for High Speed Copy" is set to "Off") The programme will be recorded in the original aspect.</p> <p>+R +RW The programme will be recorded in 4:3 aspect.</p> 
<p>When you want to copy titles in high speed mode from the HDD to DVD-R, etc.</p>	<p>-R -R DL -RW(V) +R +R DL +RW Set "Rec for High Speed Copy" to "On" before recording to the HDD. (The default setting is "On". ⇒ 61)</p> <p>You can copy titles in high speed mode (max. speed is 75X*); however, the audio and aspect settings (⇒ above) are necessary before recording to the HDD.</p> <p>* Depending on the disc, max. speed may vary.</p> <p>Record to the HDD → HDD → High speed copy to DVD-R, etc.</p>  <p>In the following cases, high speed mode does not work.</p> <ul style="list-style-type: none"> • +R +R DL +RW Titles recorded in "EP" mode and "FR" (recordings 5 hours or longer) mode • +R +R DL +RW Titles recorded in 16:9 aspect • -R -R DL -RW(V) Titles recorded in 16:9 aspect using "EP" mode or "FR" (recordings 5 hours or longer) mode
<p>When recording the "One time only recording" broadcasts</p>	<p>It is not possible to record the broadcasts that allow "One time only recording" onto DVD-R, DVD-RW, +R, +RW or 8 cm DVD-RAM discs. Use the HDD or CPRM (⇒ 84) compatible DVD-RAM.</p> <p>RAM CPRM compatible discs only.</p>  <p>-R -RW(V) +R +RW</p>  <p>(○: Can do, -: Cannot do)</p> <ul style="list-style-type: none"> • "One time only recording" titles can only be transferred from the HDD to CPRM compatible DVD-RAM (They are deleted from the HDD). They cannot be copied. • Even when copying to videotape the title may not be copied correctly because of the copy guard. • You cannot copy a playlist created from "One time only recording" titles.
<p>Playing the disc on other DVD players</p>	<p>-R -R DL -RW(V) +R +R DL The disc must be finalised after recording or copying (⇒ 58). It is necessary to finalise DVD-R, etc. on this unit after recording or copying titles to them. You can then play them as a commercially sold DVD-Video. However, the discs become play-only and you can no longer record or copy.*</p> <p>* You can record and copy again if you format DVD-RW.</p> <p>Record to DVD-R, etc. → Finalise → Play on other DVD equipment</p>  <p>+RW If the disc failed to play on other equipment, we recommend you create top menu (⇒ 58).</p>
<p>Recording to DVD-R DL and +R DL</p>	<p>You cannot directly record to a DVD-R DL and +R DL disc on this unit. Record to the HDD and then copy to the disc.</p>

Recording modes and approximate recording times

Depending on the content being recorded, the recording times may become shorter than indicated. (The times provided on this chart are an estimate.)

Recording Mode	HDD		DVD-RAM		DVD-R DVD-RW +R +RW (4.7 GB)	DVD-R DL ^{*3} (8.5 GB)	+R DL ^{*3} (8.5 GB)
	EX78 (250 GB)	EX88 (400 GB)	Single- sided (4.7 GB)	Double- sided ^{*1} (9.4 GB)			
XP (High picture quality recording mode)	55 hours	89 hours	1 hour	2 hours	1 hour	1 hour 45 min.	1 hour 45 min.
SP (Standard recording mode)	110 hours	178 hours	2 hours	4 hours	2 hours	3 hours 35 min.	3 hours 35 min.
LP (Long recording mode)	221 hours	357 hours	4 hours	8 hours	4 hours	7 hours 10 min.	7 hours 10 min.
EP (Extra long recording mode) ^{*4}	441 hours (331 hours ^{*2})	712 hours (534 hours ^{*2})	8 hours (6 hours ^{*2})	16 hours (12 hours ^{*2})	8 hours (6 hours ^{*2})	14 hours 20 min. (10 hours 45 min. ^{*2})	
FR (Flexible Recording Mode) ^{*4}	441 hours maximum	712 hours maximum	8 hours maximum	8 hours maximum for one side	8 hours maximum	14 hours 20 min.	Approximately 9 hours with video quality equivalent to LP mode.

^{*1} It is not possible to record or play continuously from one side of a double sided disc to the other.

^{*2} When "Recording time in EP mode" is set to "EP (6 Hours)" in the Setup menu (➔ 61).

The sound quality is better when using "EP (6 Hours)" than when using "EP (8 Hours)".

^{*3} You cannot record directly to DVD-R DL and +R DL discs with this unit. The table shows the recording time when copying.

+R DL You cannot copy in "EP" or "FR (recordings 5 hours or longer)" mode.

^{*4} When recording to the HDD in "EP" or "FR (recordings 5 hours or longer)" mode, you cannot perform high-speed copy to +R, +R DL or +RW discs.

● **RAM** When recording to DVD-RAM using "EP (8 Hours)" mode, play may not be possible on DVD players that are compatible with DVD-RAM. Use "EP (6 Hours)" mode if playback may be on other equipment.

HDD

● You can record up to 499 titles on HDD. (When continuously recording for long durations, titles are automatically divided every 8 hours.)

RAM -R -RW(V)

● You can record up to 99 titles on one disc.

+R +RW

● You can record up to 49 titles on one disc.

FR (Flexible Recording Mode)

You can set FR (Flexible Recording) mode when copying or programming timer recordings.

The unit automatically selects a recording rate between XP and EP (8 Hours) that will enable the recordings to fit in the remaining disc space with the best possible recording quality.

For example with a 90 minute recording to an unused DVD-RAM, the picture quality is adjusted to between "XP" and "SP".

● When recording to the HDD, picture quality is automatically adjusted to precisely fit a copied title on a 4.7 GB disc.

● All the recording modes from XP to EP appear in the display.



When the format confirmation screen is displayed

RAM -RW(V) +R +R DL +RW

When you insert a new disc or a disc recorded on a computer or other equipment, a format confirmation screen is displayed. Format the disc to use it. However, all the recorded contents are deleted.

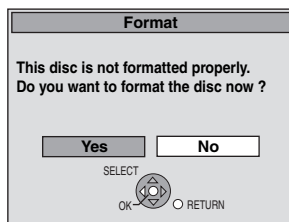

Press [◀, ▶] to select "Yes" and press [OK].

To format a disc

"Deleting all the contents—Format" (➔ 57)

When removing a recorded disc

-R -R DL -RW(V) +R +R DL

The following screen appears when you have not processed the disc for play on other equipment.

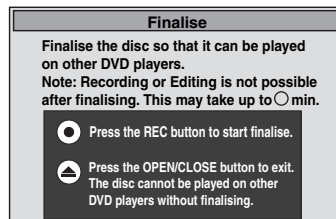

To finalise the disc

Press [● REC] on the main unit.

● You cannot stop this process once you have started it.

● If you want to set the background, play menu select or provide a disc name, select "Top Menu" (➔ 58), "Auto-Play Select" (➔ 58) or "Disc Name" (➔ 56) in "DVD Management" before finalising.

To open the tray without disc finalisation

Press [▲ OPEN/CLOSE] on the main unit.

Flexible Recording

(Recording that fits the remaining disc space)

HDD **RAM** **-R** **-RW(V)** **+R** **+RW**

The unit sets the best possible picture quality that fits the recording within the remaining disc space. The recording mode becomes FR mode.

■ Using “Flexible Rec” is convenient in these kinds of situations.

RAM **-R** **-RW(V)** **+R** **+RW**

- When the amount of free space on the disc makes selecting an appropriate recording mode difficult
- When you want to record a long programme with the best picture quality possible

HDD

- When you want to record a title to HDD so that it can then be copied to fit one 4.7 GB disc perfectly
- You do not need to edit the recorded title, or change the recording mode when copying, to fit the disc space.

e.g., Recording a 90 minute programme to disc

If you select XP mode, the programme will not fit one disc.

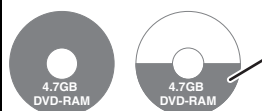

If you try to record a 90 minute programme in XP mode, only the first 60 minutes will fit on the disc and the 30 minute balance will not get recorded.

- Another disc is necessary.

If you select SP mode, the programme will fit one disc.



However there will be 30 minutes remaining disc space.

If you select “Flexible Rec” the programme will fit one disc perfectly.



■ Necessary space for recording

Preparation

- Select the channel or the external input to record.
- Press [DRIVE SELECT] to select the HDD or DVD drive.

- 1 While stopped
Press [FUNCTION MENU].
- 2 Press [▲, ▼] to select “To Others” and press [OK].
- 3 Press [▲, ▼] to select “Flexible Rec” and press [OK].

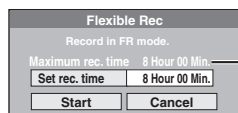

Maximum recording time
This is the maximum recording time in EP (8 Hours) mode.

- 4 Press [◀, ▶] to select “Hour” and “Min.” and press [▲, ▼] to set the recording time.

- You can also set the recording time with the numbered buttons.
- You cannot record more than 8 hours.

- 5 When you want to start recording
Press [▲, ▼, ◀, ▶] to select “Start” and press [OK].

- Recording starts.
- All the recording modes from XP to EP appear in the display.



To exit the screen without recording

Press [RETURN].

e.g., HDD

To stop recording partway

Press [■].

Remaining time of recording

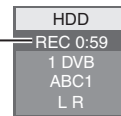

To show the remaining time

Press [STATUS ⓘ].

Playing while you are recording

HDD **RAM**

Playing from the beginning of the title you are recording—Chasing playback

Press [▶] (PLAY) during recording.

There is no sound output while searching forward or backward.

To stop play

Press [■].

To stop recording

2 seconds after play stops, press [■].

To stop timer recording

2 seconds after play stops

- 1 Press [■].
- 2 Press [◀, ▶] to select “Stop Recording” and press [OK].

Playing a title previously recorded while recording—Simultaneous rec and play

- You can also change the drive and play while recording. Press [DRIVE SELECT].

- 1 Press [DIRECT NAVIGATOR] during recording.

- 2 Press [▲, ▼, ◀, ▶] to select a title and press [OK].

- There is no sound output while searching forward or backward.

To stop play

Press [■].

To exit the Direct Navigator screen

Press [DIRECT NAVIGATOR].

To stop recording

After play stops

- 1 Press [DIRECT NAVIGATOR] to exit screen.
- 2 If the recording is on the other drive
Press [DRIVE SELECT] to select the recording drive.
- 3 Press [■].

To stop timer recording

After play stops

- 1 Press [DIRECT NAVIGATOR] to exit screen.
- 2 If the recording is on the other drive
Press [DRIVE SELECT] to select the recording drive.
- 3 Press [■].
- 4 Press [◀, ▶] to select “Stop Recording” and press [OK].

Note

“Chasing playback” and “Simultaneous rec and play” can only be used with programmes of the same encoding system (PAL/NTSC).

Copying from a video cassette recorder

e.g., Connecting to the AV3 or DV input terminals on the front
You can also connect to the AV4 input terminals on the rear.

- Turn off the unit and other video equipment before connecting.

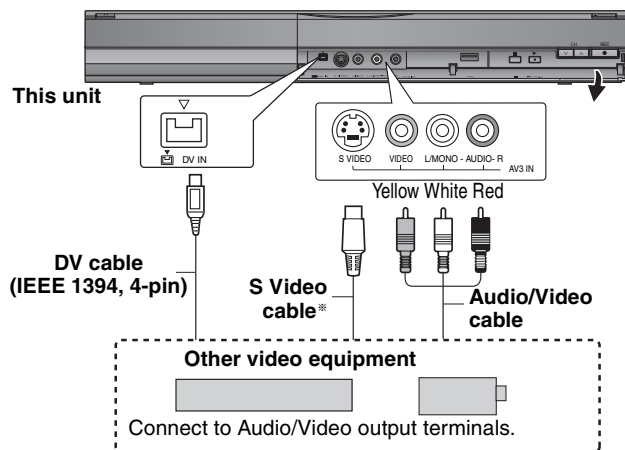

If the audio output of the other equipment is monaural
Connect to L/MONO on the AV3 input terminals at the front.

* The S VIDEO terminal achieves a more vivid picture than the VIDEO terminal.

When recording from the unit's DV terminal

- Select the type of audio recording from "Audio Mode for DV Input" in the Setup menu (⇒ 62).
- When recording from DV equipment (e.g., digital video camcorder), you can record audio/video recordings from DV tape only.
- When "Rec for High Speed Copy" (⇒ 61) is set to "On" and you make a copy, the copy will be made using the picture size selected in "Aspect for Recording" (⇒ 61) of the Setup menu.

About the aspect when recording a programme (⇒ 20)

Note

- If it becomes time for a timer recording to start while copying, the recording will start and the copying will stop.
- If video is copied from another piece of equipment to this unit, then the video quality will be degraded.

Manual recording

HDD RAM -R -RW(V) +R +RW

Preparation

- Press [DRIVE SELECT] to select the HDD or DVD drive.
- Press [REC MODE] to select the recording mode.
- When recording bilingual programmes (⇒ 20, Important notes for recording)
- When the output signal from the external equipment is NTSC, change the "TV System" to "NTSC" in the Setup menu (⇒ 64). This unit cannot record NTSC signals to discs that already have PAL signal recordings. (However, both types of programmes can be recorded onto the HDD.)
- To reduce noise in input from a video cassette recorder, set "Input NR" to "On" in the on-screen menu (⇒ 54).
- Check the time on the unit is correct.

- 1 While stopped**
Press [INPUT SELECT] to select the input channel for the equipment you have connected.
e.g., If you have connected to AV3 input terminals, select "A3".
- 2 Start play on the other equipment.**
- 3 When you want to start recording**
Press [● REC].
Recording starts.

To skip unwanted parts

Press [■] to pause recording. (Press again to restart recording.)

To stop recording

Press [■].

Almost all videos and DVD-Video on sale have been treated to prevent illegal copying. Any software that has been so treated cannot be recorded using this unit.

- Using Flexible Recording (⇒ 22), you can record the content of a video cassette (approx. 1–8 hours) to a 4.7 GB disc with the best possible quality of recording without wasting disc space.

DV automatic recording (DV Auto Rec)

HDD RAM -R -RW(V) +R +RW

HDD RAM When the "DV Auto Rec" function is used, programmes are recorded as a title while at the same time chapters are created at each break in the images and the playlist is created automatically.

Preparation

- 1 Turn off the main unit and DV equipment, then connect the equipment with the unit's DV input terminal (⇒ left).
 - 2 Turn on the main unit.
- When the output signal from the external equipment is NTSC, change the "TV System" to "NTSC" in the Setup menu (⇒ 64).

1 Turn on the DV equipment, and pause play at the point you want recording to start.

The following screen appears.

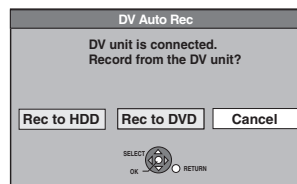

• When the screen is not displayed

- After performing step 1
- 1 Press [DRIVE SELECT] to select the HDD or DVD drive.
 - 2 Press [FUNCTION MENU].
 - 3 Press [▲, ▼] to select "To Others" and press [OK].
 - 4 Press [▲, ▼] to select "DV Auto Rec" and press [OK].
⇒ Go to step 3 (⇒ below)

2 Press [◀, ▶] to select "Rec to HDD" or "Rec to DVD" and press [OK].

3 Press [REC MODE] to select the recording mode.

4 Press [◀, ▶] to select "Rec" and press [OK].

Recording starts.

When recording finishes

The confirmation screen appears. Press [OK] to finish DV automatic recording.

To stop recording

Press [■].

Note

- Only one piece of DV equipment (e.g., digital video camcorder) can be connected to the unit via the DV input terminal.
- It is not possible to operate the unit from the connected DV equipment.
- The DV input on this unit is for use with DV equipment only. (It cannot be connected to a computer, etc.)
- The DV equipment name may not be shown correctly.
- Depending on the DV equipment, the images or audio may not be input properly.
- The date and time information on the tape of the DV equipment will not be recorded.
- You cannot record and play simultaneously.

If the DV automatic recording function does not work properly, check the connections and DV equipment settings, and turn the unit off and back on.
If that does not work, follow the instructions for manual recording (⇒ left).

Advanced timer recording

HDD RAM -R -RW(V) +R +RW

• You can enter up to 32 programmes up to a month in advance. (Each daily or weekly programme is counted as one programme.)

RAM -RW(V) +R +RW

• To use a new disc, formatting is necessary.

Preparation

- Turn on the television and select the appropriate AV input to suit the connections to this unit.
- If recording to DVD, insert a disc that you can use for recording (⇒ 14).
- Make sure that the clock settings are correct (⇒ 65).

Using G-CODE system to make timer recordings (Analogue broadcast only)

G-CODE®

G-CODE is a registered trademark of Gemstar Development Corporation. The G-CODE system is manufactured under license from Gemstar Development Corporation.

Entering G-CODE numbers is an easy way of timer recording. You can find these numbers in TV listings in newspapers and magazines.

1 Press [G-Code].

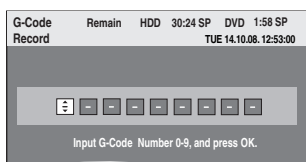

2 Press the numbered buttons to enter the G-CODE number.

Press [◀] to move back to correct a digit.

3 Press [OK].

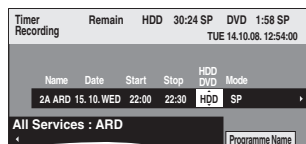

- Confirm the programme (start and end time) by using a TV magazine, etc. and make corrections if necessary using [▲, ▼, ◀, ▶] (⇒ right, step 3).
- When "--" appears in the "Name" column, you cannot set timer recording. Press [▲, ▼] to select desired programme position. After you have entered the information of a TV station, it is kept in the unit's memory.

4 Press [OK].

The timer programme is stored and the timer icon is displayed.

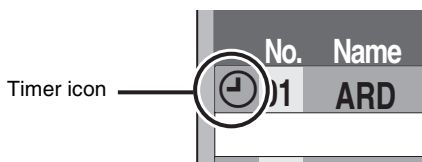

"Ⓞ" lights on the unit's display to indicate timer recording standby has been activated.

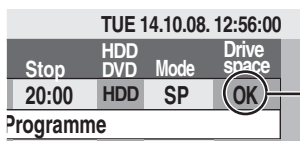

Check to make sure "OK" is displayed (⇒ 25).

Repeat steps 1–4 to programme other recordings. Press [⏻ DVD] to turn the unit off.

Manually programming timer recordings

1 Press [PROG/CHECK].

2 Press [▲, ▼] to select "New Timer Programme" and press [OK].

3 Press [▶] to move through the items and change the items with [▲, ▼].

- When "Name" is selected, you can press the "Blue" button to change the group [e.g., TV, Radio, Edit Favourites screen (⇒ 59)] and then press [▲, ▼] to select the channel you want to record.

- Press and hold [▲, ▼] to alter the Start (Start time) and Stop (Finish time) in 30-minute increments.

- You can also set Name (Programme position/TV Station Name), Date, Start (Start time), and Stop (Finish time) with the numbered buttons.

• Date

Date: Current date up to one month later minus one day

↓ ↑
Daily timer: SUN-SAT → MON-SAT → MON-FRI

↓ ↑
Weekly timer: SUN → --- → SAT

Titles recorded using the same daily or weekly timer are bundled and displayed as a "group" in the Direct Navigator screen (⇒ 29) except when using Auto Renewal Recording.

- You can also press [DRIVE SELECT] to select the recording drive.

When the recording drive is "DVD" and there is not enough remaining space, recording automatically switches to the "HDD" (⇒ 26, Relief Recording).

- You can also press [REC MODE] to change the recording mode.

- **HDD RENEW (Auto Renewal Recording)** (⇒ 26)
ON ↔ OFF

• Programme Name

Press [◀, ▶] to select "Programme Name" and press [OK]. (⇒ 44, Entering text)

4 Press [OK].

The timer programme is stored and the timer icon is displayed.



"Ⓞ" lights on the unit's display to indicate timer recording standby has been activated.

Repeat steps 2–4 to programme other recordings. Press [⏻ DVD] to turn the unit off.

To cancel recording when recording has already begun

- 1 While the unit is on
Press [DRIVE SELECT] to select the recording drive and press [■].



- 2 Press [◀, ▶] to select "Stop Recording" and press [OK].

If you stop a timer recording, it will be cancelled. However, if you have set a weekly or daily timer recording, the recording will start from the next time the timer recording is set.

To release the unit from recording standby

Even when the unit is turned off, you can display the timer recording list by pressing [PROG/CHECK].

- 1 Press [PROG/CHECK].
- 2 Press [▲, ▼] to select the programme and press the "Red" button.
 - The timer icon "Ⓞ" (⇒ right) disappears from the timer recording list.
 - You cannot cancel timer recording standby mode as long as even one timer icon "Ⓞ" (⇒ right) remains in the timer recording list.
 - Press the "Red" button again to activate timer recording standby.

Notes on timer recording

- Timer recordings are activated regardless of whether the unit is turned on/off.
- Timer recordings begin when the set time is reached even when playing.
- Timer recordings do not begin while editing or copying in normal speed mode (⇒ 45).
- If the unit is turned on when timer recording begins, it remains turned on after recording finishes. It does not turn off automatically. You can turn the unit off during timer recording.
- If the unit is not put in the timer recording standby mode at the last 10 minutes before the programmed timer recording starting time, the "Ⓞ" flashes on the unit's display.
- When you programme successive timer recordings to start immediately one after the other, the unit cannot record the part at the beginning of the later programmes.

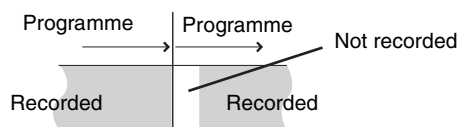

Check, change or delete a programme

- Even when the unit is turned off, you can display the timer recording list by pressing [PROG/CHECK].

Press [PROG/CHECK].

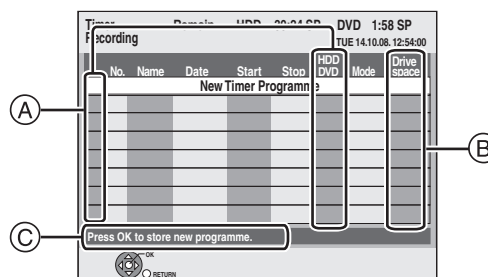

(A) Icons

- Ⓞ Timer recording standby is activated.
- This programme is currently recording.
- ⌚ Programmes are overlapped. Recording of the programme with the later start time starts when the earlier programme finishes recording.
- ⊖ You stopped a weekly or daily timer recording. The icon disappears the next time the timer programme starts recording.
- Ⓜ The disc was full so the programme failed to record.
- 🔒 The programme was copy-protected so it was not recorded.
- ⊗ The programme did not complete recording because the disc is dirty or some other reason.
- 🔄 Timer programmes set to Auto Renewal Recording (⇒ 26).
- ➡ Titles that have been rerouted to the HDD (Displayed while recording.)

HDD Recording drive is set to HDD

DVD Recording drive is set to DVD

(B) Message displayed in the "Drive space" line

- OK:** Displayed if the recording can fit in the remaining space.
- **(Date):** For recordings made daily or weekly, the display will show until when recordings can be made (up to a maximum of one month from the present time) based on the time remaining on the disc.
- ! :** It may not be possible to record because:
- there is not enough space left.
 - the number of possible titles has reached its maximum.
- Relief:** Timer programmes that will be relief recorded to the HDD.

(C) Channel name, programme name and other information are displayed.

■ To change a programme

Press [▲, ▼] to select the programme and press [OK]. (⇒ 24, right column, step 3)

■ To delete a programme

Press [▲, ▼] to select the programme and press [DELETE *].

You can also delete a programme with the following steps

- 1 Press [▲, ▼] to select the programme and press [OPTION].
- 2 Press [▲, ▼] to select "Delete" and press [OK].

■ To exit the timer recording list

Press [PROG/CHECK].

Note

- Programmes that failed to record are deleted from the timer recording list at 4 a.m. two days later.

Relief Recording

When the recording drive is "DVD" and there is not enough remaining space, recording automatically switches to the "HDD". If there is no disc in the tray or the disc cannot be recorded on or when timer recording starts while copying, the recording drive will be altered to the HDD.

- The Direct Navigator shows which programmes were relief-recorded ("↔" is displayed.) (→ 29).
- If the time remaining on the HDD is insufficient, as much of the programme as possible will be recorded onto the HDD.

Auto Renewal Recording

HDD

If you record a programme onto HDD repeatedly everyday or every week using timer recording, the unit will record the new programme over the old one.

This function can be used only when weekly recording or daily recording is selected.

- 1 Press [PROG/CHECK].
- 2 Press [▲, ▼] to select the programme and press [OK].
- 3 Press [◀, ▶] to select "RENEW" column.
- 4 Press [▲, ▼] to select "ON" and press [OK].

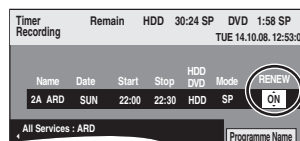

Note

- If a programme set for Auto Renewal Recording is protected or while play back is taking place from the HDD, or while copying, the programme will not be overwritten. Instead the programme set for recording will be saved as a separate programme, and this programme will be the one to be overwritten when the next Auto Renewal Recording takes place.
- Playlists made from programmes that were set for Auto Renewal Recording are deleted along with auto renewal.
- When there is not enough space on the HDD, the programme may not be recorded completely.

Operations in the TV Guide system

Basic operations

Press [GUIDE] to switch between Landscape view and Portrait view.

Landscape view

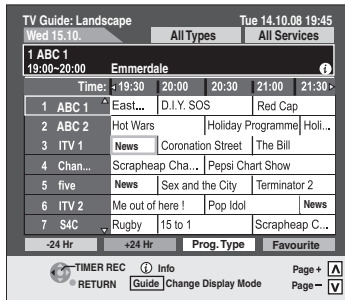

Portrait view

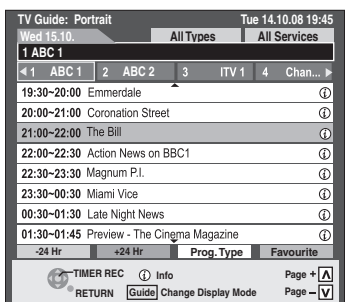

When the TV Guide displays “No information available for analogue services” or the empty TV Guide list

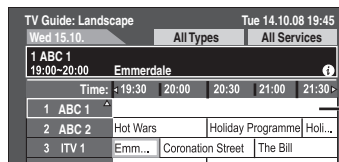

- Some digital broadcast may not send programme information. Set the timer recording manually or with the G-CODE system (→ 24).

Selecting the programme from the desired programme type or group

This function lets you display a TV Guide list sorted by programme type (e.g. Movies, Sport) or group (e.g. Free TV, Radio).

- From the desired programme type
Press the “Yellow” button to display the list of programme type.
From the desired group
Press the “Blue” button to display the list of groups.
- Press [▲, ▼] to select the desired item.

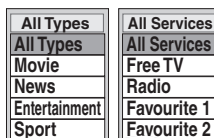

- Press [OK].

- A list appears with all programmes of the selected item.
- When you select the Landscape view, the unit displays programmes in grey that do not belong to the selected programme type.

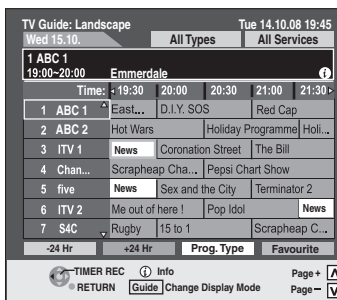

e.g., Programme type, “News” is selected in step 2 of Landscape view.

Note

The broadcasters allocate individual programmes to topic areas. This function does not work properly unless the information which distinguishes the programme type and groups sent from broadcast stations is correct.

- Press [▲, ▼, ◀, ▶] to select the programme.

To return to the previous TV Guide list before you have selected the programme type or groups

Select “All Types” of the programme type and “All Services” of the groups in step 2 above.

To return to the previous screen
Press [RETURN].

To exit the screen
Press [EXIT].

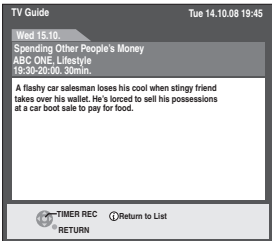
To change channels	<p>Landscape view Press [▲, ▼] to select a channel.</p> <p>Portrait view Press [◀, ▶] to select a channel. The TV Guide list appears for this channel.</p>
To view a programme list for another day	<ul style="list-style-type: none"> Jump ahead 24 hours Press the “Green” button to jump ahead by one day. Jump back 24 hours Press the “Red” button. You can only jump back to the current date. Past information cannot be viewed.
To browse through the TV Guide list	Press [^ v CH].
To see programme information (Programmes with the ⓘ symbol)	<p>Press [STATUS ⓘ]. Additional information (programme name, programme duration, broadcast time, description) is available for these programmes.</p>  <p>Press [▲, ▼] to scroll up and down. To show other pages Press [CH ^] (Previous) or [v CH] (Next). Press [STATUS ⓘ] again to return to the programme list.</p>

Operation during play

• Depending on the media, some operations may not be possible.

Stop	<p>Press [■]. The stopped position is memorized.</p> <p>Resume play function Press [▶] (PLAY) to restart from this position.</p> <p>Stopped position</p> <ul style="list-style-type: none"> • If [■] is pressed several times, the position is cleared in some cases. • The position is cleared if the tray is opened. • CD VCD and MP3/DivX : The position is cleared if the unit is turned off.
Pause	<p>Press [II]. Press [II] again or [▶] (PLAY) to restart play.</p>
Search	<p>Press [◀◀] or [▶▶].</p> <ul style="list-style-type: none"> • The speed increases up to 5 steps. (+R +R DL +RW) up to 3 steps) • Press [▶] (PLAY) to restart play. • Audio is heard during first level search forward. CD and MP3 : Audio is heard during all levels of search. DivX : Audio is not heard during all levels of search.
Skip	<p>During play or while paused, press [◀◀] or [▶▶].</p> <p>Skip to the title, chapter or track you want to play.</p> <ul style="list-style-type: none"> • Each press increases the number of skips. • DivX : Press [◀◀] to return to the beginning of the title currently playing.
Starting from a selected title	<p>Press the numbered buttons. Play starts from the selected title, chapter or track.</p> <ul style="list-style-type: none"> • HDD e.g., 5: [0] → [0] → [5] 15: [0] → [1] → [5] • MP3 and JPEG e.g., 5: [0] → [0] → [0] → [5] 15: [0] → [0] → [1] → [5] • Other discs Input a 2-digit number e.g., 5: [0] → [5] 15: [1] → [5] • This works only when stopped (the screen on the right is displayed on the television) with some discs. • VCD (with playback control) If you press the numbered buttons while stopped (the above screen is displayed on the television) you can cancel PBC. (Elapsed play time appears on the unit's display.)
Quick View HDD RAM	<p>Press and hold [▶] (PLAY/×1.3). Play speed is quicker than normal.</p> <ul style="list-style-type: none"> • Press again to return to normal speed.
Slow-motion HDD RAM -R -R DL -RW(V) +R +R DL +RW DVD-V -RW(VR) VCD	<p>While paused, press [◀◀] or [▶▶].</p> <p>The speed increases up to 5 steps.</p> <ul style="list-style-type: none"> • Press [▶] (PLAY) to restart play. • VCD Forward direction [▶▶] only. • The unit will pause if slow-motion play is continued for approximately 5 minutes (excluding DVD-V VCD).
Frame-by-frame HDD RAM -R -R DL -RW(V) +R +R DL +RW DVD-V -RW(VR) VCD	<p>While paused, press [◀] (◀II) or [▶] (II▶).</p> <p>Each press shows the next frame.</p> <ul style="list-style-type: none"> • Press and hold to change in succession forward or backward. • Press [▶] (PLAY) to restart play. • VCD Forward direction [▶] (II▶) only.

Skipping the specified time (Time Slip)

HDD RAM

-R -R DL -RW(V) +R +R DL

(This function does not work with finalised discs.)

+RW -RW(VR)

- 1 Press [TIME SLIP].
- 2 Press [▲, ▼] to select the time and press [OK].

Play skips the specified time.

- Each time you press [▲, ▼], the time increases [▲] or decreases [▼] by 1 minute intervals. (Press and hold for 10-minute intervals.)

This automatically disappears after approximately 5 seconds. To show the screen again press [TIME SLIP] again.



Manual Skip

HDD RAM

-R -R DL -RW(V) +R +R DL

(This function does not work with finalised discs.)

+RW -RW(VR)

Press [MANUAL SKIP].

Each time you press, play restarts approximately 1 minute later.

Create Chapter

(⇒ 38, Title/Chapter)

HDD RAM

Press [CREATE CHAPTER].

Chapters are divided at the point pressed.

- Press [◀◀, ▶▶] to skip to the start of a chapter.

Changing audio during play

Press [AUDIO].

HDD RAM -RW(VR) VCD, DivX and analogue broadcast

L → R

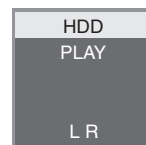

e.g., "L R" is selected

DVD-V

You can change the audio channel number each time you press the button. This allows you to change things like the soundtrack language (⇒ 54, Soundtrack).



e.g., English is selected.

Note

You cannot change the audio type in the following cases.

- When a DVD-R, DVD-R DL, DVD-RW (DVD-Video format), +R, +R DL or +RW disc is in the disc tray while DVD drive is selected.
- When the recording mode is XP and "Audio Mode for XP Recording" is set to "LPCM" (⇒ 62).
- When "Rec for High Speed Copy" is set to "On" (The default setting is "On" ⇒ 61).

Selecting recorded programmes (titles) to play—Direct Navigator

HDD RAM -R -R DL -RW(V) +R +R DL +RW -RW(VR)

You can quickly find the recorded titles and easily play them. You can also sort the titles or edit the Groups of titles.

1 Press [DIRECT NAVIGATOR].

HDD RAM When “VIDEO” is not selected, press the “Red” button to select “VIDEO”.

2 Press [▲, ▼, ◀, ▶] to select the title and press [OK].

You can also select titles with the numbered buttons (All Titles screen only).

e.g., **HDD**

5:	[0] → [0] → [5]	5:	[0] → [5]
15:	[0] → [1] → [5]	15:	[1] → [5]
115:	[1] → [1] → [5]		

To show other pages

Press [▲, ▼, ◀, ▶] to select “Previous” or “Next” and press [OK]. (Thumbnail Display only)

• You can also press [◀◀, ▶▶] to show other pages.

To exit the screen

Press [DIRECT NAVIGATOR].

Direct Navigator screen icons

- Currently recording.
- 🔒 Title protected.
- 📄 Title that was not recorded due to recording protection (Digital broadcasts etc.)
- ✕ Title cannot be played [When copying a title to the HDD, or when data is damaged etc.]
- ➡ Titles that have been rerouted to the HDD (➡ 26, Relief Recording)
- 📄 Title with “One time only recording” restriction (➡ 84, CPRM)
- 📄 Groups of titles (**HDD** only)
- ▶ Title that was recorded but has not yet been played (**HDD** only)
- N (NTSC) Title recorded using a different encoding system from that of the TV system currently selected on the unit.
- P (PAL) Title recorded using a different encoding system from that of the TV system currently selected on the unit.
 - Alter the “TV System” setting on this unit to suit (➡ 64).

Switching the Direct Navigator appearance

“Grouped Titles”/“All Titles” **HDD**
 “Table Display”/“Thumbnail Display”

- ① While the Direct Navigator screen is displayed Press [OPTION].
- ② Press [▲, ▼] to select the item and press [OK]. e.g.,



Grouped Titles screen

Two or more titles recorded in the Daily/weekly timer recording mode are bundled and displayed as one item.

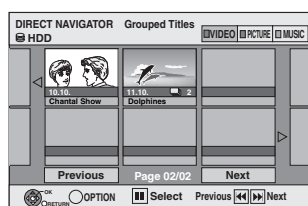

(in Thumbnail Display)

Select the item marked with and press [OK] to display the bundled titles.

All Titles screen

Displays all titles.

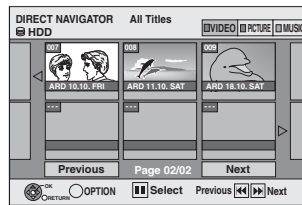

(in Thumbnail Display)

To sort the titles for easy searching

HDD (All Titles screen in Table Display only)

This function is convenient when searching for one title to playback from many titles.

- ① Press [OPTION].
- ② Press [▲, ▼] to select “Sort” and press [OK].
- ③ Press [▲, ▼] to select the item and press [OK].

If you select an item other than “No.”

- The Direct Navigator screen will reappear after playback of the selected title has finished. (You cannot play titles continuously.)
- Skip and Time Slip will only function with the title currently being played back.
- If you exit the Direct Navigator screen, or switch to another Direct Navigator screen, the sort will be cancelled.

To play grouped titles **HDD**

- ① Press [▲, ▼, ◀, ▶] to select the group and press [OK].
- ② Press [▲, ▼, ◀, ▶] to select the title and press [OK].

To edit the group of titles **HDD**

HDD (Grouped Titles screen only)

- ① Press [▲, ▼, ◀, ▶] to select a title or a group and press [III]. A check mark is displayed. Repeat this step until you select all necessary titles.
 - Press [III] to cancel.
- ② Press [OPTION].
- ③ Press [▲, ▼] to select the option and press [OK].



Create Group:

Press [◀, ▶] to select “Create” and press [OK]. Selected titles are bundled to form a group.

Release Grouping:

Press [◀, ▶] to select “Release” and press [OK].

- When a group of titles has been selected, all the titles in the group are released.
- When a title in a group has been selected, the title is released from the group.

Regarding the group name

The name of the first title in the group is used as the group name.

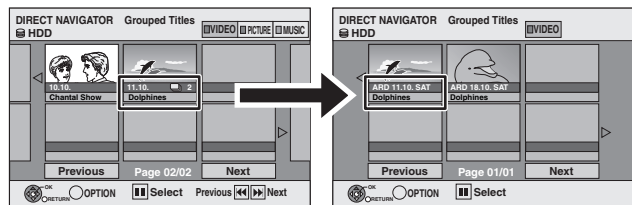

To change the group name

- 1 Press [▲, ▼, ◀, ▶] to select the group and press [OPTION].
 - 2 Press [▲, ▼] to select “Edit” and press [OK].
 - 3 Press [▲, ▼] to select “Enter Name” and press [OK].
 - 4 Enter the name. (➡ 44, Entering text)
- Even if the group name is changed, the title names in the group will not be changed.

Instructions/notes regarding SD cards and SD drive are applicable to the DMR-EX88 model only.

Showing the menu screen

CD

- 1 Insert the disc.
- 2 If the disc contains different file types

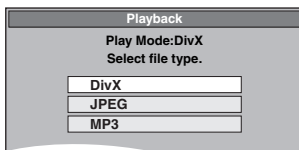

Press [▲, ▼] to select the item and press [OK].

Otherwise,
Press [DIRECT NAVIGATOR].

USB SD

- 1 Insert the USB memory or the SD card.

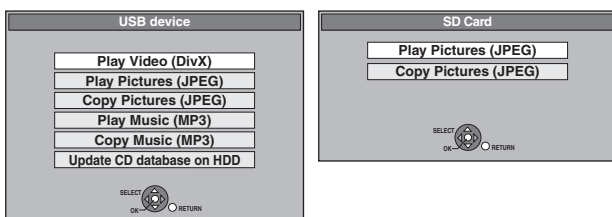

- 2 Press [▲, ▼] to select the item and press [OK].

■ Changing the file type to play

CD USB

- 1 Press [RETURN] several times to exit the menu.
- 2 Press [FUNCTION MENU].

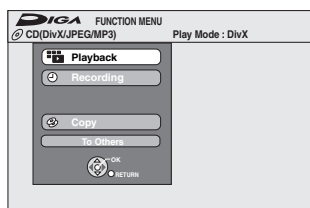

- 3 **CD**
Press [▲, ▼] to select "Playback" and press [OK].

USB

- ① Press [▲, ▼] to select "To Others" and press [OK].
- ② Press [▲, ▼] to select "USB device" and press [OK].
- 4 Press [▲, ▼] to select the item and press [OK].

Playing DivX video contents

-R -R DL CD USB

You can play DivX video contents recorded with a computer onto DVD-R, DVD-R DL, CD-R/CD-RW and USB memory.

1 Show DivX Menu screen.

(← left, Showing the menu screen)

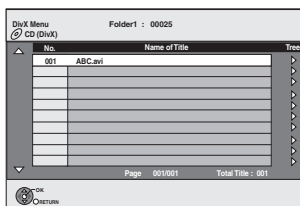

- Files are treated as titles.

2 Press [▲, ▼] to select the title and press [OK].

Play starts on the selected title.

- You can also select the title with the numbered buttons.
e.g., 5: [0] → [0] → [5]
15: [0] → [1] → [5]

To stop playing

Press [■].

To show other pages

Press [◀, ▶].

To exit the screen

Press [DIRECT NAVIGATOR].

Note

- Picture sizes set at the recording time may prevent the unit from showing pictures in the adequate aspect. You may be able to adjust the aspect through the TV.
- Successive play is not possible.
- Playback is not possible if recording is performed on the HDD drive or the DVD drive.

Using the tree screen to find a folder

- 1 While the file list is displayed
Press [▶] while a title is highlighted to display the tree screen.

F: Selected folder no./Total folder no. including DivX title.

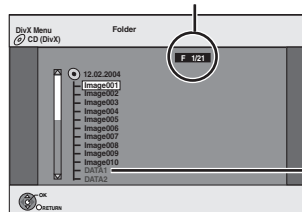

You cannot select folders that contain no compatible files.

- 2 Press [▲, ▼] to select a folder and press [OK].

The file list for the folder appears.

To return to the previous screen

Press [RETURN].

Regarding DivX VOD content

DivX Video-on-Demand (VOD) content is encrypted for copyright protection. In order to play DivX VOD content on this unit, you first need to register the unit.

Follow the on line instructions for purchasing DivX VOD content to enter the unit's registration code and register the unit. For more information about DivX VOD, visit www.divx.com/vod

Display the unit's registration code.

(⇒ 65, "DivX Registration" in "Others" tab)

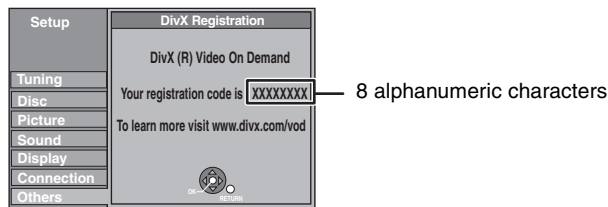

- After playing DivX VOD content for the first time, another registration code is then displayed in "DivX Registration". Do not use this registration code to purchase DivX VOD content. If you use this code to purchase DivX VOD content, and then play the content on this unit, you will no longer be able to play any content that you purchased using the previous code.
- If you purchase DivX VOD content using a registration code different from this unit's code, you will not be able to play this content. ("Authorisation Error." is displayed.)

Regarding DivX content that can only be played a set number of times

Some DivX VOD content can only be played a set number of times. When you play this content, the remaining number of plays is displayed. You cannot play this content when the number of remaining plays is zero. ("Rental Expired." is displayed.)

When playing this content

- The number of remaining plays is reduced by one if
 - you press [⏏ DVD].
 - you press [■].
 - you press [DIRECT NAVIGATOR].
 - you press [⏮] or [⏪, ⏩] etc. and arrive at another content or the start of the content being played.
 - timer recording starts on the HDD.
 - you press [DRIVE SELECT] to change the drive.
- Resume functions do not work.

Playing MP3 files

CD USB

You can play MP3 files recorded with a computer onto a CD-R/ CD-RW and USB memory.

- You cannot play MP3 files on the USB memory while recording or copying.

1 Show MP3 Menu screen.

(⇒ 30, Showing the menu screen)

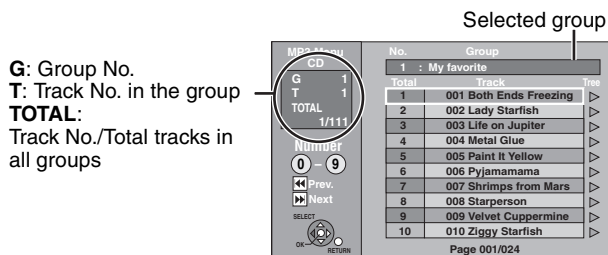

- Files are treated as tracks and folders are treated as groups.

2 Press [▲, ▼] to select the track and press [OK].

Play starts on the selected track.

- "⏮" indicates the track currently playing.
- You can also select the track with the numbered buttons.
 - e.g., 5: [0] ⇒ [0] ⇒ [0] ⇒ [5]
 - 15: [0] ⇒ [0] ⇒ [1] ⇒ [5]

Using the tree screen to find a group

- 1 While the file list is displayed Press [▶] while a track is highlighted to display the tree screen.

Selected group No. /Total groups

If the group has no track, "–" is displayed as group number.

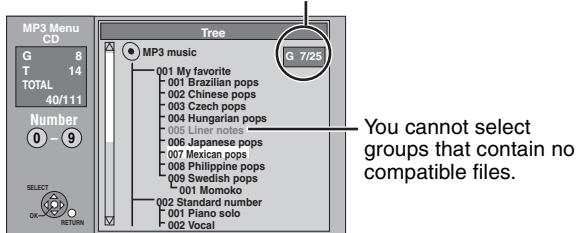

- 2 Press [▲, ▼, ◀, ▶] to select a group and press [OK].

The file list for the group appears.

To return to the previous screen

Press [RETURN].

To stop playing

Press [■].

To show other pages

Press [⏮, ⏩].

To exit the screen

Press [DIRECT NAVIGATOR].

Instructions/notes regarding SD cards and SD drive are applicable to the DMR-EX88 model only.

Playing still pictures

HDD **RAM** **CD** **USB** **SD**

- You can play still pictures recorded with a computer onto a CD-R/CD-RW and USB memory.
- You cannot play still pictures while recording or copying.
- Inserting, removing the SD card **EX88** (⇒ 14)

1 Show Album View screen.

CD **USB** **SD**

(⇒ 30, Showing the menu screen)

HDD **RAM**

While stopped

- 1 Press [DRIVE SELECT] to select the drive.
- 2 Press [DIRECT NAVIGATOR].
When "PICTURE" is not selected, press the "Green" button to select "PICTURE".

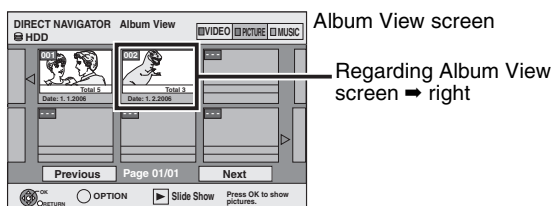

Direct Navigator screen icons

- Picture and folder protected.
- Album that has not yet been viewed (**HDD** **RAM**)

To show other pages

Press [**▲**, **▼**, **◀**, **▶**] to select "Previous" or "Next" and press [OK].

- You can also press [**◀◀**, **▶▶**] to show other pages.

2 Press [**▲**, **▼**, **◀**, **▶**] to select the album and press [OK].

You can also select album with the numbered buttons.

e.g.,

5: [0] ⇒ [0] ⇒ [5]

15: [0] ⇒ [1] ⇒ [5]

115: [1] ⇒ [1] ⇒ [5]

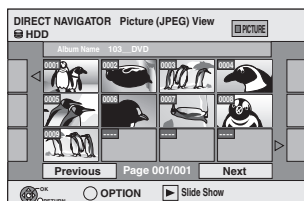

e.g., HDD

3 Press [**▲**, **▼**, **◀**, **▶**] to select the still picture and press [OK].

You can also select still pictures with the numbered buttons.

e.g.,

5: [0] ⇒ [0] ⇒ [0] ⇒ [5] 115: [0] ⇒ [1] ⇒ [1] ⇒ [5]

15: [0] ⇒ [0] ⇒ [1] ⇒ [5] 1115: [1] ⇒ [1] ⇒ [1] ⇒ [5]

- Press [**◀**, **▶**] to display the previous or next still picture.
- Useful functions during still picture play (⇒ 33)

To return to the Album View screen or Picture (JPEG) View screen

Press [RETURN].

To exit the screen

Press [DIRECT NAVIGATOR].

■ Regarding Album View screen

Still pictures copied from USB memories and SD cards are grouped by the shooting date in the HDD or DVD-RAM.

You can arrange these still pictures and create an album (⇒ 42).

HDD **RAM**

Grouped by date

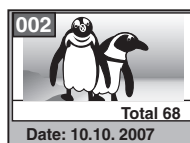

Number of pictures/Shooting date

HDD **RAM** **CD** **USB** **SD**

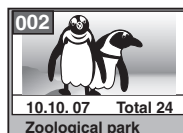

Album



Shooting date/Number of pictures/Album name

- Depending on the digital camera, the editing software on the PC etc., the information about the recording date may not be displayed. In this case, the date will appear as [--.--].

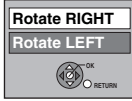
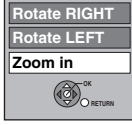
Useful functions during still picture play

<p>Start Slide Show</p> <p>Slide Show Setting</p>	<p>You can display still pictures one by one at a constant interval.</p> <p>While the Album View screen is displayed</p> <p>1 Press [▲, ▼, ◀, ▶] to select the album.</p> <p>2 Press [▶] (PLAY).</p> <p>You can also start Slide Show with the following steps.</p> <p>While the Album View screen is displayed</p> <p>① Press [▲, ▼, ◀, ▶] to select the desired album and press [OPTION].</p> <p>② Press [▲, ▼] to select "Start Slide Show" and press [OK].</p> <p>● To change the display interval</p> <p>1 Press [▲, ▼] to select "Slide Show Setting" in step ② and press [OK].</p> <p>2 Press [▲, ▼] to select "Display interval".</p> <p>3 Press [◀, ▶] to select the desired interval (0–30 seconds) and press [OK].</p> <p>● Repeat Play</p> <p>1 Press [▲, ▼] to select "Slide Show Setting" in step ② and press [OK].</p> <p>2 Press [▲, ▼] to select "Repeat Play".</p> <p>3 Press [◀, ▶] to select "On" or "Off" and press [OK].</p>	
<p>Rotate</p>	<p>While playing</p> <p>1 Press [OPTION].</p> <p>2 Press [▲, ▼] to select "Rotate RIGHT" or "Rotate LEFT" and press [OK].</p> <p>● Rotation information will not be stored.</p> <ul style="list-style-type: none"> – [CD] [USB] Still pictures – When disc or album is protected – When played on other equipment – When copying pictures – When changing date <p>● If you remove the SD card while the DIRECT NAVIGATOR screen is displayed, picture rotation information may not be properly stored. Remove the SD card after you exit the DIRECT NAVIGATOR screen.</p>	
<p>Zoom in</p> <p>Zoom out</p>	<p>While playing</p> <p>1 Press [OPTION].</p> <p>2 Press [▲, ▼] to select "Zoom in" and press [OK].</p> <p>● To return the picture to its original size, press [▲, ▼] to select "Zoom out" in step 2 and press [OK].</p> <p>● When zooming in, the picture may be cut off.</p> <p>● The enlargement information will not be stored.</p> <p>● The "Zoom in/Zoom out" function is only available for still pictures smaller than 640 × 480 pixels.</p>	
<p>Properties</p>	<p>While playing</p> <p>Press [STATUS ⓘ] twice.</p> <p>e.g., HDD</p> <p>To exit the picture properties screen</p> <p>Press [STATUS ⓘ].</p>	 <p>Shooting date</p>

To play music CD

Preparation

Press [DRIVE SELECT] to select the DVD drive.

1 Insert a music CD.

The menu is automatically displayed.

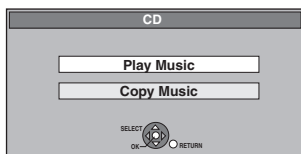

2 Press [▲, ▼] to select “Play Music” and press [OK].

The unit starts accessing the Gracenote® Database (→ 52) and searches for the title information.



If search results indicate that multiple titles were found Press [▲, ▼] to select the appropriate title and press [OK].

3 Press [▲, ▼] to select the track and press [OK].

You can also select the track with the numbered buttons.

e.g.,

5: [0] → [5]

15: [1] → [5]

To exit the screen

Press [DIRECT NAVIGATOR].
Playback continues.

To play music recorded on HDD

Copying music to HDD (→ 52)

Preparation

Press [DRIVE SELECT] to select the HDD drive

1 Press [DIRECT NAVIGATOR].

When “MUSIC” is not selected, press the “Yellow” button to select “MUSIC”.

2 Press [▲, ▼] to select “Play CD on HDD” or “Play MP3 on HDD” and press [OK].

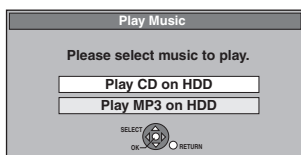

3 Press [▲, ▼] to select the album/group and press [OK].

You can also select the album/group with the numbered buttons.

e.g.,

5: [0] → [0] → [5]

15: [0] → [1] → [5]

115: [1] → [1] → [5]

4 Press [▲, ▼] to select the track and press [OK].

You can also select the track with the numbered buttons.

CD

e.g.,

5: [0] → [5]

15: [1] → [5]

MP3

e.g.,

5: [0] → [0] → [0] → [5]

115: [0] → [1] → [1] → [5]

15: [0] → [0] → [1] → [5]

1115: [1] → [1] → [1] → [5]

To return to the previous screen

Press [RETURN].

To exit the screen

Press [DIRECT NAVIGATOR].

Note

- You cannot play music tracks on HDD while recording or copying.
- When this unit is not operated for approximately 5 minutes while the screen is being displayed, the screen saver is displayed. To return to the previous screen, press [OK].

Useful functions during music play

Operations during play

Stop	<p>Press [■]. The stopped position is memorized. Press [▶] (PLAY) to restart from this position.</p> <ul style="list-style-type: none"> • If [■] is pressed several times, the position is cleared. • The position is cleared if the unit is turned off.
Pause	<p>Press [⏸]. Press [⏸] again or [▶] (PLAY) to restart play.</p>
Search	<p>Press [◀◀] or [▶▶]. The speed increases up to 5 steps. Press [▶] (PLAY) to restart play.</p>
Skip	<p>During play or while paused, press [◀◀] or [▶▶]. Skip to the track you want to play. • Each press increases the number of skips.</p>
Repeat Play HDD	<p>You can select the item which you want to repeat.</p> <p>While playing</p> <ol style="list-style-type: none"> 1 Press [OPTION]. 2 Press [▲, ▼] to select “Repeat Play Setting” and press [OK]. 3 Press [▲, ▼] to select the item and press [OK]. <ul style="list-style-type: none"> • Select “Off” to cancel repeat play.
Sort HDD	<p>You can change the order of the Album View (CD)/ Group View (MP3) alphabetically.</p> <p>While Album View (CD) screen or Group View (MP3) screen is displayed</p> <ol style="list-style-type: none"> 1 Press [OPTION]. 2 Press [▲, ▼] to select “Sort” and press [OK]. 3 Press [▲, ▼] to select “Album Name” or “Group Name” and press [OK]. <p>To cancel the sorted screen Press [▲, ▼] to select “No.” and press [OK].</p>
Properties HDD CD	<p>While Track View (CD) screen or Track View (MP3) screen is displayed</p> <ol style="list-style-type: none"> 1 Press [OPTION]. 2 Press [▲, ▼] to select “Properties” and press [OK]. <ul style="list-style-type: none"> • To exit the Properties screen, press [OK].

FUNCTION MENU window

By using the FUNCTION MENU window you may access the main functions quickly and easily.

1 Press [FUNCTION MENU].

Functions displayed depend on the selected drive or type of disc.

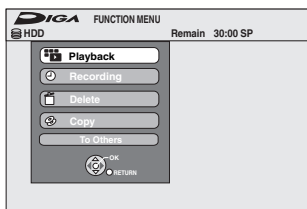

2 Press [▲, ▼] to select an item and press [OK].

• If you select “To Others” and press [OK], the following screen appears. Press [▲, ▼] to select an item and press [OK].

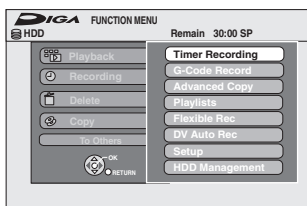

• If you press [RETURN], you can return to the previous screen.

Playback	You can select and play recorded programmes (⇒ 16, 29), change the Play Mode (DivX, JPEG, MP3) (⇒ 30), etc.
Recording	You can easily find programmes you want to watch and set them for timer recording (⇒ 18).
Delete	You can delete items using DELETE Navigator (⇒ 19, 43).
Copy	You can copy recorded titles using COPY Navigator (⇒ 46).
Timer Recording	You can start programming timer recording (⇒ 24).
G-Code Record	You can make timer recording setting by entering G-CODE numbers (⇒ 24).
Advanced Copy	You can make a copy list and then copy (⇒ 47).
EX88 Copy New Pictures	You can copy the new still pictures on an SD card (⇒ 50).
Playlists	You can create playlists by grouping your favourite chapters (⇒ 40).
Flexible Rec	The unit sets the best possible picture quality that fits the recording within the remaining disc space (⇒ 22).
DV Auto Rec	DV automatic recording function (⇒ 23)
Setup	You can change the unit's settings using Setup menu (⇒ 59).
HDD Management DVD Management	You can manage the HDD, discs and cards through formatting, finalising and other operations (⇒ 56).
EX88 Card Management	
Copy Music CD	You can copy music CD to the HDD (⇒ 52).
USB device	This unit displays the menu to help you start USB operations (⇒ 30). • “USB device” appears when a compatible USB device is connected.

To exit the FUNCTION MENU window
Press [FUNCTION MENU].

To pause the TV programme you are watching—Pause Live TV

You can pause the TV programme you are watching using this unit's tuner and resume later by temporarily saving it on the HDD. This is useful when you have to briefly stop watching TV to run an errand. If you stop the Pause Live TV function, then the TV programme temporarily saved on the HDD will be deleted.

1 Turn on the television and select the appropriate AV input to suit the connections to this unit.

2 Turn on this unit and press [▲ ▼ CH] to select the channel.

3 When you want to pause the TV programme Press [II].

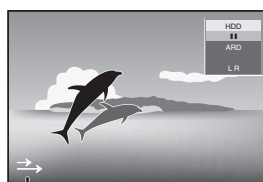

This icon indicates that Pause Live TV is working. You can turn off this icon (⇒ 63, Pause Live TV Icon).

4 When you want to resume Press [▶] (PLAY)

- The programme is saved on the HDD in SP recording mode (⇒ 21) regardless of the recording mode and the drive selected before starting saving.
- At least 1 hour up to 8 hours of TV programmes can be temporarily saved on the HDD. (This may vary depending on the HDD free space.)

Operation during Pause Live TV

Search	Press [◀◀, ▶▶].
Pause	Press [II]. • Press [▶] (PLAY) to restart.
Quick View	Press and hold [▶] (PLAY/×1.3). • Press again to return to the normal speed.
Slow-motion	While paused, press [◀◀] or [▶▶]. The speed increases up to 5 steps. • Press [▶] (PLAY) to restart play.
Stop Pause Live TV	1 Press [■]. 2 Press [◀, ▶] to select “Yes” and press [OK].

Note

- The Pause Live TV function automatically stops when a timer recording starts.
- The Pause Live TV function does not work if the clock is not set.
- The Pause Live TV function does not work
 - while recording
 - while timer recording, etc.
- You cannot change audio or subtitle during resume play.
- The first 30 minutes is deleted every 30 minutes after the HDD is full or the saving lasts 8 hours.
- The Pause Live TV function stops automatically 24 hours after started.

Linked operations with the TV (VIERA Link “HDAVI Control™”)

You can enjoy linked operations with the TV and receiver by using “HDAVI Control”.

What is VIERA Link “HDAVI Control”?

VIERA Link “HDAVI Control” is a convenient function that offers linked operations of this unit, and a Panasonic TV (VIERA) or receiver under “HDAVI Control”. You can use this function by connecting the equipment with the HDMI cable. See the operating instructions for connected equipment for operational details.

- VIERA Link “HDAVI Control”, based on the control functions provided by HDMI which is an industry standard known as HDMI CEC (Consumer Electronics Control), is a unique function that we have developed and added. As such, its operation with other manufacturers’ equipment that supports HDMI CEC cannot be guaranteed.
- **This unit supports “HDAVI Control 3” function.**
“HDAVI Control 3” is the newest standard (current as of December, 2007) for Panasonic’s HDAVI Control compatible equipment. This standard is compatible with Panasonic’s conventional HDAVI equipment.
- Please refer to individual manuals for other manufacturers’ equipment supporting VIERA Link function.

Preparation

- 1 Connect this unit to your TV using an HDMI cable (⇒ 8) or to your receiver using an HDMI cable (⇒ 69).
- 2 Set “VIERA Link” to “On” (⇒ 64). (The default setting is “On”.)
- 3 Set the “HDAVI Control” operations on the connected equipment (e.g., TV).
- Set the input channel on VIERA to suit the terminal to be used as “HDAVI Control”.
- 4 Turn on all “HDAVI Control” compatible equipment and select this unit’s input channel on the connected TV so that the “HDAVI Control” function works properly.

Also when the connection or settings are changed, repeat this procedure.

What you can do with “HDAVI Control”

Download from the TV	When you connect the unit to a TV for the first time, the station list data is automatically copied from the TV to the unit and the TV stations are assigned to the programme positions on the unit in the same order as on the TV (⇒ 9).
(When the TV is on) Easy playback	When the TV is on and the following operations are performed, the TV’s input will automatically switch to HDMI input mode and the TV displays the corresponding action. (Picture or sound may not be available for the first few seconds.) Press [FUNCTION MENU]*1, [▶] (PLAY)*2, [DIRECT NAVIGATOR], [GUIDE], [PROG/CHECK], [G-Code] etc.
(When the TV is off) Power on link	When the TV is off and the following operations are performed, the TV will automatically turn on and displays the corresponding action. (Picture or sound may not be available for the first few seconds.) Press [FUNCTION MENU]*1, [▶] (PLAY)*2, [DIRECT NAVIGATOR], [GUIDE], [PROG/CHECK], [G-Code] etc. • DVD-V CD VCD and MP3 The TV is automatically turned on when you insert the discs.
Power off link	When you set the TV to standby mode, the unit is also automatically set to standby mode. The unit is automatically set to standby mode even if the FUNCTION MENU screen etc. is displayed during playback or when the unit set to a timer recording. Even if the TV is set to standby mode, the unit will not be set to standby mode at the same time when recording, copying, finalising etc. • When this unit is connected to an “HDAVI Control” compatible Panasonic receiver with an HDMI cable, the receiver will also turn off.

*1 This button is available only when this unit is on.

*2 When this button is pressed, the playback image is not immediately displayed on the screen and it may not be possible to watch the contents from where playback started.

In this case, press [◀◀] or [◀◀] to go back to where playback started.

Note

- These functions may not work normally depending on the equipment condition.
- About “HDAVI Control” function, read the manual of the connected equipment (e.g., TV) too.

Easy control only with VIERA remote control

If you connect this unit to the TV that has "HDAVI Control 2" or "HDAVI Control 3" function with an HDMI cable, you can enjoy using more convenient functions.

You can operate this unit using the following buttons on the TV remote control.

[▲, ▼, ◀, ▶], [OK], [RETURN], [EXIT], [OPTION] and the coloured buttons.

Use the remote control for this unit to operate any other buttons (numbered buttons, etc.) that are not listed above.

- The operation of this unit may be interrupted when you press buttons on the TV remote control other than those listed above.
- The TV displays the TV tuner's picture when the linked operation is finished.

Using the FUNCTION MENU window to operate this unit

- This function is available with the TV which has "HDAVI Control 2" or "HDAVI Control 3" function.

Refer to the TV operating instructions for operating the TV.

- 1 Display this unit's "FUNCTION MENU" window using the TV remote control.**
 - If this unit is set to standby mode, it will automatically turn on.
- 2 Select the item you want to operate with the TV remote control, and press [OK].**

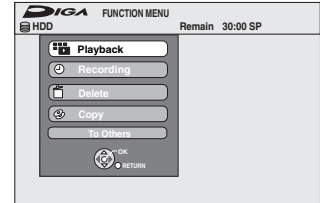

About the FUNCTION MENU window (⇒ 35).

Pause live TV programme

- This function is available with the TV which has "HDAVI Control 3" function.

You can pause the TV programme you are watching and resume later by temporarily saving it on the HDD. This is useful when you have to briefly stop watching TV to run an errand. If you stop the Pause Live TV function, then the TV programme temporarily saved on the HDD will be deleted.

Refer to the TV operating instructions for operating the TV.

- 1 When you want to pause the TV programme Turn on the "Pause Live TV" function using the TV remote control.**
 - This unit turns on automatically.
- 2 When you want to resume Display the Control Panel (⇒ below) and press [OK].**
 - The TV programme resumes.

To stop Pause Live TV

Press [▼] while the Control Panel is displayed.

Refer to "Note" on page 35, "To pause the TV programme you are watching—Pause Live TV".

Using the OPTION menu window to operate this unit

- This function is available with the TV which has "HDAVI Control 2" or "HDAVI Control 3" function.

By using the TV remote control, you can play discs using the "Control Panel" (⇒ below) and display the Top Menu for DVD-Video.

- 1 Press [OPTION].**

e.g.,



Note

You cannot use the OPTION menu while the Top Menu for DVD-Video is displayed and while DVD-Video is copying.

- 2 Select an item then press [OK].**

Control Panel	Control Panel is displayed (⇒ below).
FUNCTION MENU	FUNCTION MENU window is displayed (⇒ above).
Top Menu DVD-V	Top menu is displayed (⇒ 16).
Menu DVD-V	Menu is displayed (⇒ 16).
Drive Select	Select the HDD, DVD or SD drive
Rotate RIGHT (JPEG)	Rotate the still picture (⇒ 33).
Rotate LEFT (JPEG)	
Zoom in (JPEG)	Enlarge or shrink the still picture (⇒ 33).
Zoom out (JPEG)	

Using the Control Panel

Using the Control Panel, you can operate search backward, search forward, stop, etc. with the TV remote control.

Perform steps 1 and 2 of "Using the OPTION menu window to operate this unit" (⇒ above).

The Control Panel is displayed (⇒ right).

- When playing a title or DVD-Video, etc.
 - [▲]: Pause, [▼]: Stop, [◀]: Search backward, [▶]: Search forward, [OK]: Play, [EXIT]: Exit the screen.
- While playing still pictures
 - [▼]: Stop, [◀]: View previous picture, [▶]: View next picture, [EXIT]: Exit the screen.

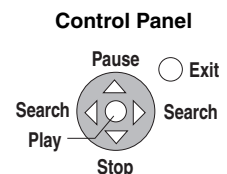

■ When you want to leave the TV on and set only this unit to standby mode

Press [DVD] on this unit's remote control and set to standby mode.

■ When not using "HDAVI Control"

Set "VIERA Link" in the Setup menu to "Off" (⇒ 64).

HDD RAM
-R -R DL -RW(V) +R +R DL (You cannot edit finalized discs.)
+RW -RW(VR)

Title/Chapter
 Programmes are recorded as a single title consisting of one chapter.

Start End

HDD RAM You can divide a title into multiple chapters. Each section between the division points becomes a chapter. (⇒ 28, 39, Create Chapter)

HDD RAM You can change the order of chapters and create a playlist (⇒ 40).

- The maximum number of items on a disc:

HDD
 – Titles: 499
 – Chapters: Approx. 1000 per title
 (Depends on the state of recording.)

RAM -R -R DL -RW(V) +R +R DL +RW
 – Titles: 99 (+R +R DL +RW 49 titles)
 – Chapters: Approx. 1000 (+R +R DL +RW Approx. 254)
 (Depends on the state of recording.)

Note

- Once deleted, divided or partially deleted, recorded content cannot be restored to its original state. Make certain before proceeding.
- You cannot edit during recording or copying, etc.
- Restricted recording information remains even after editing (e.g. dividing a title etc).
- **+R +R DL** Each time you edit a title the information is saved to the free space on the disc. If you do this numerous times, the amount of free space decreases.
 We recommend that you edit on the HDD and then copy to disc.

Editing titles/chapters and playing chapters

You can modify (remove unnecessary parts, divide, etc.) recorded programmes.

Preparation

- Turn on the television and select the appropriate AV input to suit the connection to this unit.
- Turn the unit on.
- Press [DRIVE SELECT] to select the drive containing the recorded title to be edited.
- **RAM** Release protection (⇒ 56, Setting the protection).

1 During play or while stopped
Press [DIRECT NAVIGATOR].

HDD RAM When “VIDEO” is not selected, Press the “Red” button to select “VIDEO”.

2 Press [**▲**, **▼**, **◀**, **▶**] to select the title.

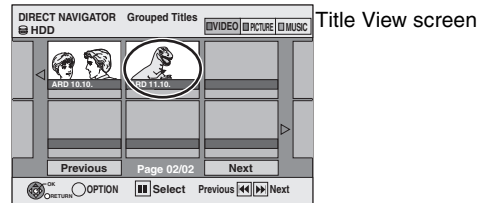

To show other pages

Press [**▲**, **▼**, **◀**, **▶**] to select “Previous” or “Next” and press [OK].

- You can also press [**◀◀**, **▶▶**] to show other pages.

Multiple editing

Select with [**▲**, **▼**, **◀**, **▶**] and press [**■**]. (Repeat.)
 A check mark appears. Press [**■**] again to cancel.

3 Press [OPTION].

4 Press [**▲**, **▼**] to select the operation and press [OK].

- If you select “Edit”, press [**▲**, **▼**] to select the operation and press [OK].

Refer to “Title operations” (⇒ 39).

- To edit the group of titles **HDD** (⇒ 29)
- Switching the Direct Navigator appearance (⇒ 29)
- Playing still pictures (⇒ 32)
- To play music recorded on HDD (⇒ 34)

■ If you select “Chapter View”

5 Press [**▲**, **▼**, **◀**, **▶**] to select the chapter.

To start play ⇒ Press [OK].
 To edit ⇒ Step 6.

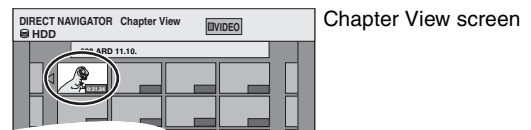

- To show other pages/Multiple editing (⇒ above)

6 Press [OPTION], then [**▲**, **▼**] to select the operation and press [OK].

Refer to “Chapter operations” (⇒ 39).

- You can go back to Title View.

To return to the previous screen
 Press [RETURN].

To exit the screen
 Press [DIRECT NAVIGATOR].

Title operations

After performing steps 1–4 (⇒ 38)

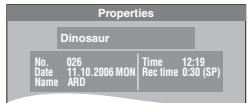
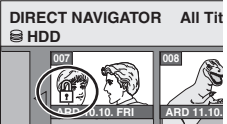
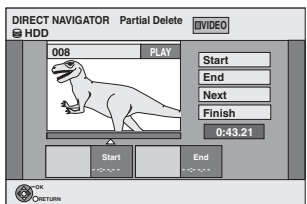
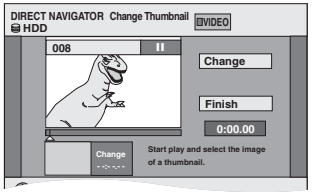
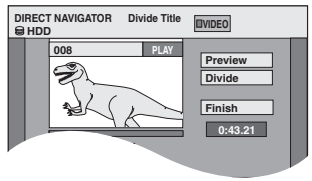
<p>Delete*</p> <p>HDD RAM -R -R DL -RW(V) +R +R DL +RW</p>	<p>Press [◀, ▶] to select “Delete” and press [OK].</p> <ul style="list-style-type: none"> Once deleted, the recorded contents are lost and cannot be restored. Make certain before proceeding. The available recording space on DVD-R, DVD-R DL, +R or +R DL does not increase when you delete titles. Available recording space on DVD-RW (DVD-Video format) and +RW increases only when the last recorded title is deleted. It does not increase if other titles are deleted (⇒ 19).
<p>Properties</p> <p>HDD RAM -R -R DL -RW(V) +R +R DL +RW -RW(VR)</p>	<p>Information (e.g., time and date) is shown.</p> <ul style="list-style-type: none"> Press [OK] to exit the screen. 
<p>Enter Name</p> <p>HDD RAM -R -R DL -RW(V) +R +R DL +RW</p>	<p>You can give names to recorded titles. (⇒ 44, Entering text)</p> <ul style="list-style-type: none"> HDD Even if the group name is changed, the title names in the group will not be changed.
<p>Set up Protection*</p> <p>Cancel Protection*</p> <p>HDD RAM +R +R DL +RW</p>	<p>If set, this will protect the title from accidental deletion.</p> <p>Press [◀, ▶] to select “Yes” and press [OK]. The lock symbol appears when the title is protected.</p> 
<p>Partial Delete</p> <p>HDD RAM (⇒ below, For your reference)</p>	<p>You can remove unnecessary part of the recording.</p> <ol style="list-style-type: none"> Press [OK] at the start point and end point of the section you want to delete. Press [▲, ▼] to select “Finish” and press [OK]. <ul style="list-style-type: none"> Select “Next” and press [OK] to delete other sections. Press [◀, ▶] to select “Delete” and press [OK]. 
<p>Change Thumbnail</p> <p>HDD RAM -R -R DL -RW(V) +R +R DL +RW (⇒ below, For your reference)</p>	<p>You can change an image to be shown as the thumbnail picture in the Title View.</p> <ol style="list-style-type: none"> Press [▶] (PLAY) to start play. Press [OK] when the image you want to use as a thumbnail is shown. To change the thumbnail Restart play and press [▲, ▼] to select “Change”, then press [OK] at the point you want to change. Press [▲, ▼] to select “Finish” and press [OK]. 
<p>Divide Title</p> <p>HDD RAM (⇒ below, For your reference)</p>	<p>You can divide a title into two.</p> <ol style="list-style-type: none"> Press [OK] at the point you want to divide the title. Press [▲, ▼] to select “Finish” and press [OK]. Press [◀, ▶] to select “Divide” and press [OK]. To confirm the division point Press [▲, ▼] to select “Preview” and press [OK]. (The unit plays 10 seconds before and after the division point.) To change the division point Restart play and press [▲, ▼] to select “Divide”, then press [OK] at the point where you want to divide the title. <p>Note</p> <ul style="list-style-type: none"> The divided titles retain the title name and CPRM property (⇒ 84) of the original title. Video and audio just before and after the dividing point may momentarily cut out. HDD Divided titles form a group of titles. 

* Multiple editing is possible.

Chapter operations

After performing steps 1–6 (⇒ 38)

<p>Delete Chapter*</p> <p>HDD RAM</p>	<p>Press [◀, ▶] to select “Delete” and press [OK].</p> <ul style="list-style-type: none"> Once deleted, the recorded contents are lost and cannot be restored. Make certain before proceeding. Select “Combine Chapters” (⇒ below) when you only want to delete the division point between chapters. (The recorded contents will not be deleted.)
<p>Create Chapter</p> <p>HDD RAM (⇒ below, For your reference)</p>	<p>Select the point where you want to start a new chapter while viewing the title.</p> <ol style="list-style-type: none"> Press [OK] at the point you want to divide. <ul style="list-style-type: none"> Repeat this step to divide at other points. Press [▲, ▼] to select “Finish” and press [OK]. 
<p>Combine Chapters</p> <p>HDD RAM</p>	<p>Press [◀, ▶] to select “Combine” and press [OK].</p> <ul style="list-style-type: none"> The selected chapter and following chapter are combined.

* Multiple editing is possible.

For your reference

- Use Search (⇒ 28), Time Slip (⇒ 28) to find the desired point.
- To find the desired point correctly, use Slow-motion (⇒ 28) and Frame-by-frame (⇒ 28).
- To skip to the start or end of a title, press [◀◀] (start) or [▶▶] (end).

You can arrange the chapters (⇒ 38) to create a playlist.

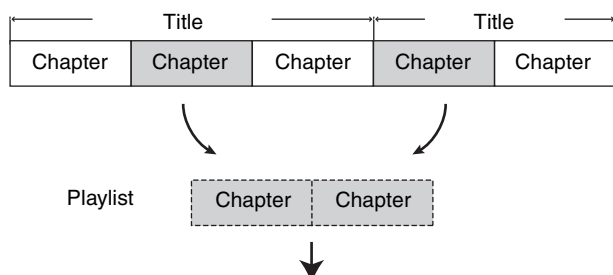

Copying (⇒ 45) a playlist will create a title.

- Playlists are not recorded separately so this doesn't use much capacity.
- Editing chapters in a playlist does not modify the source titles and source chapters.
- You cannot create or edit playlists while recording or copying.

HDD RAM

- The maximum number of items on a disc:
 - Playlists: 99
 - Chapters in playlists: Approx. 1000
 (Depends on the state of recording.)
- If you exceed the maximum numbers of items for a disc, all the items entered will not be recorded.

Creating playlists

HDD RAM

Preparation

- Turn on the television and select the appropriate AV input to suit the connection to this unit.
- Turn the unit on.
- Press [DRIVE SELECT] to select the drive containing the recorded title to be edited.
- **RAM** Release protection (⇒ 56, Setting the protection).
- You cannot create or edit a playlist while recording or while copying.
- Playlists must be made in accordance with the encoding system currently selected in "TV System" (⇒ 64).

- 1** While stopped
Press [FUNCTION MENU].
- 2** Press [▲, ▼] to select "To Others" and press [OK].

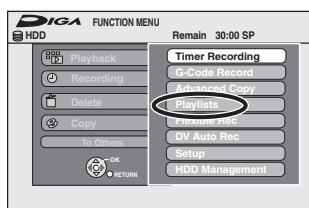

- 3** Press [▲, ▼] to select "Playlists" and press [OK].
- 4** Press [▲, ▼, ◀, ▶] to select "Create" and press [OK].

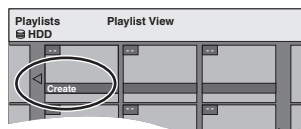

- 5** Press [◀, ▶] to select the source title and press [▼].
 - Press [OK] to select all the chapters in the title, then skip to step 7.

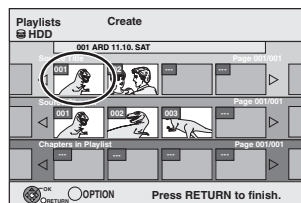

- 6** Press [◀, ▶] to select the chapter you want to add to a playlist and press [OK].
Press [▲] to cancel.

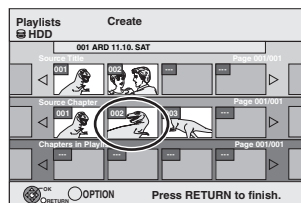

- You can also create a new chapter from the source title. Press [OPTION] to select "Create Chapter" and press [OK] (⇒ 39, Create Chapter).

- 7** Press [◀, ▶] to select the position to insert the chapter and press [OK].

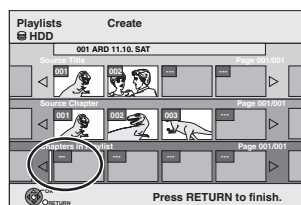

- Press [▲] to select other source titles.
- Repeat steps 6–7 to add other chapters.

- 8** Press [RETURN].
All the selected scenes become the playlist.

To return to the previous screen
Press [RETURN].

To exit the screen
Press [EXIT].

Editing and playing playlists/chapters

HDD RAM

-RW(VR) (Play only)

- 1 While stopped
Press [FUNCTION MENU].
- 2 Press [▲, ▼] to select “To Others”
and press [OK].
- 3 Press [▲, ▼] to select “Playlists” and
press [OK].
- 4 Press [▲, ▼, ◀, ▶] to select the
playlist.
To start play ⇒ Press [OK].
To edit ⇒ Step 5.



Playlist View screen

- To show other pages/Multiple editing (⇒ 38)

- 5 Press [OPTION], then [▲, ▼] to select
the operation and press [OK].
• If you select “Edit”, press [▲, ▼] to select the operation and
press [OK].

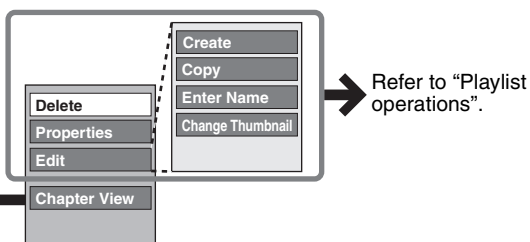

- If you select “Chapter View”

- 6 Press [▲, ▼, ◀, ▶] to select the
chapter.
To start play ⇒ Press [OK].
To edit ⇒ Step 7.

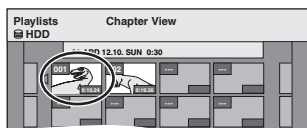

Chapter View screen

- To show other pages/Multiple editing (⇒ 38)

- 7 Press [OPTION], then [▲, ▼] to select
the operation and press [OK].

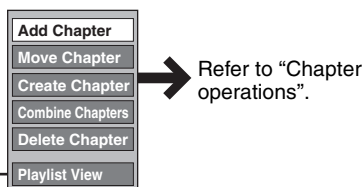

- You can go back to Playlist View.

To return to the previous screen
Press [RETURN].

To exit the screen
Press [EXIT].

Playlist operations

After performing steps 1–5 (⇒ left)

<p>Delete*</p> <p>HDD RAM</p>	<p>Press [◀, ▶] to select “Delete” and press [OK]. Once deleted, the playlists are lost and cannot be restored. Make certain before proceeding.</p>				
<p>Properties</p> <p>HDD RAM -RW(VR)</p>	<p>Playlist information (e.g., total time and date) is shown. • Press [OK] to exit the screen.</p> <div style="border: 1px solid gray; padding: 5px; width: fit-content; margin: 10px auto;"> <p style="text-align: center; font-size: small;">Properties</p> <p style="text-align: center; font-weight: bold; font-size: small;">Dinosaur</p> <table style="width: 100%; border-collapse: collapse; font-size: x-small;"> <tr> <td style="border-right: 1px solid gray; padding: 2px;">No. 10</td> <td style="padding: 2px;">Date 12.10.2006 TUE</td> </tr> <tr> <td style="border-right: 1px solid gray; padding: 2px;">Chapters 002</td> <td style="padding: 2px;">Total 0:30:53</td> </tr> </table> <p style="text-align: center; font-size: x-small;">© 2006 CREATOR</p> </div>	No. 10	Date 12.10.2006 TUE	Chapters 002	Total 0:30:53
No. 10	Date 12.10.2006 TUE				
Chapters 002	Total 0:30:53				
<p>Create</p> <p>HDD RAM</p>	<p>(⇒ 40, Creating playlists, Step 5–8)</p>				
<p>Copy*</p> <p>HDD RAM</p>	<p>Press [◀, ▶] to select “Copy” and press [OK]. • The copied playlist becomes the newest one in the playlist view screen.</p>				
<p>Enter Name</p> <p>HDD RAM</p>	<p>You can give names to playlists. (⇒ 44, Entering text)</p>				
<p>Change Thumbnail</p> <p>HDD RAM</p>	<p>(⇒ 39, Change Thumbnail)</p>				

* Multiple editing is possible.

Chapter operations

HDD RAM

After performing steps 1–7 (⇒ left)

- Editing chapters in a playlist does not modify the source titles and source chapters.

<p>Add Chapter</p>	<p>(⇒ 40, Creating playlists, Step 5–7)</p>
<p>Move Chapter</p>	<p>Press [▲, ▼, ◀, ▶] to select the position to insert the chapter and press [OK].</p> <div style="border: 1px solid gray; padding: 5px; width: fit-content; margin: 10px auto;"> <p style="text-align: center; font-size: small;">Playlists Move Chapter</p> <p style="text-align: center; font-size: x-small;">01 12:10 SUN 0:30</p> <p style="text-align: center; font-size: x-small;">Previous Page 01/01 Next</p> <p style="text-align: center; font-size: x-small;">© 2006 CREATOR</p> </div>
<p>Create Chapter</p>	<p>(⇒ 39, Create Chapter)</p>
<p>Combine Chapters</p>	<p>(⇒ 39, Combine Chapters)</p>
<p>Delete Chapter*</p>	<p>(⇒ 39, Delete Chapter) The playlist itself is deleted if you delete all the chapters in it.</p>

* Multiple editing is possible.

Instructions/notes regarding SD cards and SD drive are applicable to the DMR-EX88 model only.

Editing still pictures (JPEG)

HDD RAM SD

- You can edit pictures and albums.
- You cannot edit still pictures recorded on CD-R/CD-RW and USB memory.

Preparation

- Press [DRIVE SELECT] to select the HDD, DVD or SD drive.
- **RAM SD** Release protection (⇒ 56, Setting the protection).

1 Press [DIRECT NAVIGATOR].

HDD RAM When "PICTURE" is not selected, press the "Green" button to select "PICTURE".

2 Editing an album:

Select the album to be edited and press [OPTION].

- When you want to create an album using "Create Album", press [OPTION] without selecting album.

Editing a still picture:

- ① Select the album which contains the still picture to edit and press [OK].
- ② Select the still pictures to edit and press [OPTION].

To show other pages

Press [▲, ▼, ◀, ▶] to select "Previous" or "Next" and press [OK].

- You can also press [◀◀, ▶▶] to show other pages.

Multiple editing

Select with [▲, ▼, ◀, ▶] and press [■]. (Repeat.) A check mark appears. Press [■] again to cancel.

3 Press [▲, ▼] to select the operation and press [OK].

■ To edit the album

(e.g., **HDD**)

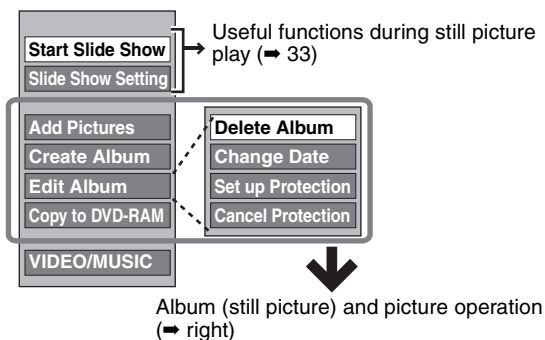

■ To edit still picture

(e.g., **HDD**)

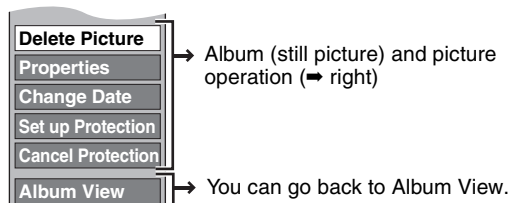

To return to the previous screen

Press [RETURN].

To exit the screen

Press [DIRECT NAVIGATOR].

Album (still picture) and picture operation

After performing steps 1–3 (⇒ left)

Delete Picture* Delete Album*

HDD RAM SD

Press [◀, ▶] to select "Delete" and press [OK].

- Once deleted, the recorded contents are lost and cannot be restored. Make certain before proceeding.
- When deleting an album, files other than the still picture files inside the album will also be deleted. (This does not apply to folders under the album concerned.)

Change Date*

HDD RAM

You can change the date of the picture.

- ① Press [◀, ▶] to select the item and press [▲, ▼] to change.
- ② Press [OK].

Enter Album Name

HDD RAM SD

You can give names to albums.

(⇒ 44, Entering text)

- Album names input using this unit may not be displayed on other equipment.

Set up Protection* Cancel Protection*

HDD RAM SD

If set, this will protect the still picture or album from accidental deletion.

Press [◀, ▶] to select "Yes" and press [OK].

The lock symbol appears when the still picture or album is protected.

- Even if the protection setting is used by this unit to protect an album, the album may be deleted by another unit.

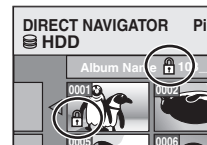

Properties

HDD RAM CD
USB SD

Information (e.g., image size and file size) is shown.

- To exit the Properties screen, press [OK].

Copy to DVD-RAM

HDD

Press [◀, ▶] to select "Start" and press [OK].

You cannot copy if multiple albums are selected.

Copy to HDD

RAM

Add Pictures Create Album

HDD RAM SD

① Press [◀, ▶] to select "Start" or "Yes" and press [OK].

② Press [▲, ▼, ◀, ▶] to select the album that contains the still picture you want to add and press [OK].

③ Press [▲, ▼] to select the item and press [OK].

- If "Select pictures to copy" is selected: Select the still picture you want to add and press [OK].
- If "Copy all pictures" is selected: All the still pictures in the album will be copied.

④ Press [◀, ▶] to select "Yes" or "No" and press [OK].

- If you want to continue copying, select "Yes" and go to step ②.

Only for "Create Album"

⑤ Press [◀, ▶] to select "Yes" or "No" and press [OK].

- If "Yes" is selected: You can give names to albums. (⇒ 44, Entering text)
- If "No" is selected: The album name is automatically given.

* Multiple editing is possible.

[Change Date : Only when the "Picture (JPEG) View" screen is displayed]

Note

- Timer recordings do not start when performing "Change Date", "Copy to DVD-RAM", "Copy to HDD", "Add Pictures" or "Create Album".

Editing music

HDD

Preparation

Press [DRIVE SELECT] to select the HDD drive.

1 Press [DIRECT NAVIGATOR].

When "MUSIC" is not selected, press the "Yellow" button to select "MUSIC".

2 Press [▲, ▼] to select "Play CD on HDD" or "Play MP3 on HDD" and press [OK].

3 Editing an album/group

Press [▲, ▼] to select the album/group and press [OPTION].

Editing a track

① Press [▲, ▼] to select the album/group and press [OK].

② Press [▲, ▼] to select the track and press [OPTION].

4 Press [▲, ▼] to select the operation and press [OK].

■ To edit the album (CD)/group (MP3)

e.g., Album View (CD)

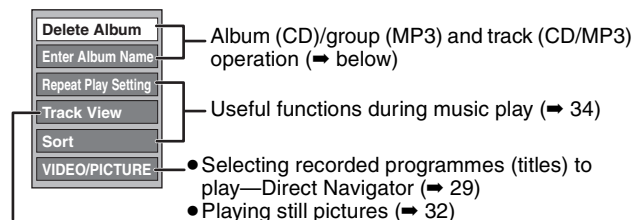

⇒ below

■ To edit the track (CD/MP3)

e.g., Track View (MP3)

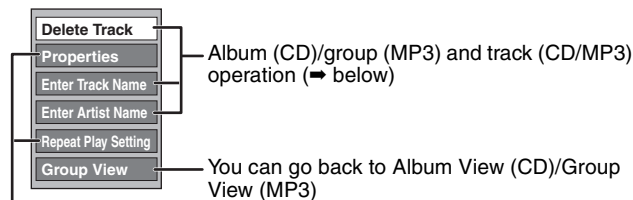

Useful functions during music play (⇒ 34)

To return to the previous screen

Press [RETURN].

To exit the screen

Press [DIRECT NAVIGATOR].

Album (CD)/group (MP3) and track (CD/MP3) operation

After performing step 1-4 (⇒ above)

Delete Album (CD) Delete Group (MP3) Delete Track (MP3)	Press [◀, ▶] to select "Delete" and press [OK]. ● Once deleted, the recorded contents are lost and cannot be restored. Make certain before proceeding.
Enter Album Name (CD) Enter Group Name (MP3) Enter Track Name (CD/MP3)	You can give names to albums/groups and tracks. (⇒ 44, Entering text)
Enter Artist Name (CD/MP3)	You can edit the artist name of the track. (⇒ 44, Entering text)

Note

● Timer recordings do not start while editing music.

Deleting still pictures and music using DELETE Navigator

HDD RAM SD

1 While stopped

Press [FUNCTION MENU].

2 Press [▲, ▼] to select "Delete" and press [OK].

3 **HDD RAM**

Press the colour button to select "PICTURE" or "MUSIC".

HDD If you pressed the "Yellow" button, press [▲, ▼] to select "Delete CD on HDD" or "Delete MP3 on HDD" and press [OK].

4 Deleting an album (still picture), album (CD) or group (MP3)

Press [▲, ▼, ◀, ▶] to select the item and press [DELETE *].

Deleting a still picture or track (MP3)

① Press [▲, ▼, ◀, ▶] to select the album or group which contains the still picture or track to delete and press [OK].

② Press [▲, ▼, ◀, ▶] to select the still picture or track and press [OK].

You can confirm the item that you have selected using the option menu.

- Refer to option menu operations for the "Album View" (⇒ 42, step 3).
- Refer to option menu operations for the "Picture (JPEG) View" (⇒ 42, step 3).
- Refer to option menu operations for the "Album View (CD)" (⇒ left, step 4).
- Refer to option menu operations for the "Track View (MP3)" (⇒ left, step 4).

To show other pages [Album (still picture) and still picture only]

Press [◀, ▶] to show other pages.

Multiple deleting [Album (still picture) and still picture only]

Select with [▲, ▼, ◀, ▶] and press [■]. (Repeat.) A check mark appears. Press [■] again to cancel.

5 Press [◀, ▶] to select "Delete" and press [OK].

The item is deleted.

To return to the previous screen

Press [RETURN].

To exit the screen

Press [EXIT].

Note

You cannot delete a track (CD) individually.

Instructions/notes regarding SD cards and SD drive are applicable to the DMR-EX88 model only.

HDD RAM -R -R DL -RW(V) +R +R DL +RW
SD

You can give names to recorded titles, etc.

The maximum number of characters:

HDD RAM	Characters
Title	64 (44*)
Playlist	64
Album of still pictures	36
Album (CD) (HDD)	40
Group (MP3) (HDD)	40
Track (CD/MP3) (HDD)	40
Artist (CD/MP3) (HDD)	40
Disc (RAM)	64

*Title name for timer recording

-R -R DL -RW(V) +R +R DL +RW	Characters
Title	44
Disc	40

SD	Characters
Album of still pictures	36
Broadcast	Characters
Favourite group 1–4	14

Note

If a name is long, parts of it may not be shown in some screens.

1 Show Enter Name screen.

Title (timer recording)

Select "Programme Name" in step 3 on page 24, right column.

Title

Select "Enter Name" in step 4 on page 38.

Playlist

Select "Enter Name" in step 5 on page 41.

Disc

Select "Disc Name" in step 1 of "Providing a name for a disc" on page 56.

Album (CD) (HDD**)**

Select "Enter Album Name" in step 4 of "Editing music" on page 43.

Group (MP3) (HDD**)**

Select "Enter Group Name" in step 4 of "Editing music" on page 43.

Track (CD/MP3) (HDD**)**

Select "Enter Track Name" in step 4 of "Editing music" on page 43.

Artist (CD/MP3) (HDD**)**

Select "Enter Artist Name" in step 4 of "Editing music" on page 43.

Album of still pictures

Select "Enter Album Name" in step 3, "Editing still pictures (JPEG)" on page 42.

Favourite group 1–4

Press the "Red" button in step ② of the right column on page 59, "To change the name of a group in the "Favourite" column".

2 Press [▲, ▼, ◀, ▶] to select a character and press [OK].

Repeat this step to enter other characters.

• To delete a character

Press [▲, ▼, ◀, ▶] to select the character in the name field and press [II]. (The selected characters are deleted.)

• Using the numbered buttons to enter characters

e.g., entering the letter "R"

① Press [7] to move to the 7th row.

② Press [7] twice to highlight "R".

③ Press [OK].

• To enter a space

Press [DELETE *] and press [OK].

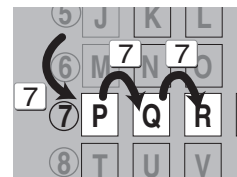

3 Press [■] (Set).

"Writing..." appears then the screen returns to the Title view screen and so on.

To end partway

Press [RETURN].

Text is not added.

For your reference

If you enter a long name, only part of it is shown in the Top Menu after finalisation (➡ 58). When entering a title name, the name that will appear in the Top Menu can be previewed in "Top Menu Preview" window.



Name field: shows the text you have entered

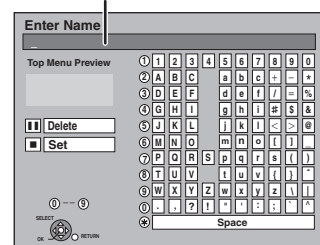

Copying titles or playlists

Instructions/notes regarding SD cards and SD drive are applicable to the DMR-EX88 model only.

		Copy		Advanced Copy	
Features		Easy copying from HDD to DVD with no difficult settings.		Make a copy list and then copy. You can set the unit to copy titles or playlists in the way you want.	
Copy direction	HDD → DVD	○		○	
	DVD → HDD	-		○ RAM -RW(VR) +RW DVD-V (Only from a finalised disc)	
High speed mode copy ^{*1}		○		○ DVD-V You cannot perform high-speed copy with finalised discs. +RW You cannot perform high-speed copy from +RW to HDD.	
Changing recording mode		-		○ ^{*2}	
Finalise ^{*3}		-R -R DL -RW(V) +R +R DL Automatically finalised		-R -R DL -RW(V) +R +R DL Can be selected	
		High speed mode	Normal speed mode	High speed mode	Normal speed mode
Copying SD Video from an SD card (EX88) (⇒ 49)		-	-	○ HDD RAM only	-
Copying playlists ^{*4}		-	-	○	○
Are chapters maintained?		○	- ^{*5}	○	- ^{*5}
Are thumbnails maintained?		○	- ^{*6}	○ ^{*7}	- ^{*6}
Recording and Playing while Copying		-	-	○ ^{*8}	-

- ^{*1} To high speed copy titles (or playlists created from those titles), set "Rec for High Speed Copy" to "On" before recording to the HDD (The default setting is "On", ⇒ 61). However in the following cases, copying to DVD-R, DVD-R DL, DVD-RW (DVD-Video format), +R, +R DL and +RW using the high speed mode does not work.
- When arranging multiple titles for copying, if any titles are recorded with "Rec for High Speed Copy" to "Off", then you cannot perform with high-speed copy.
 - Playlists created from titles using a variety of recording modes or multiple titles using FR recording mode.
 - Playlists mixed with a variety of audio types (Dolby Digital and LPCM, etc.).
 - Titles that contain many deleted segments.
 - **EX88** Titles that have been copied to the HDD from an SD card or a Panasonic digital video camera with HDD (SD Video).
 - **+R +R DL +RW** Titles recorded in "EP" mode and "FR (recordings 5 hours or longer)" mode. (Displayed ►►!)
 - **+R +R DL +RW** Titles recorded in 16:9 aspect
 - **-R -R DL -RW(V)** Titles recorded in 16:9 aspect using "EP" mode or "FR" (recordings 5 hours or longer) mode
- ^{*2} If you select a recording mode with better picture quality than the original, the picture quality does not improve. (However it does prevent against degradation of picture quality.)
- +R DL** You cannot copy in "EP" or "FR (recordings 5 hours or longer)" mode.
- ^{*3} You cannot select "Top Menu" or "Auto-Play Select".
- If you want to set auto-play select or the background colour, select "Top Menu" or "Auto-Play Select" in "DVD Management" before copying (⇒ 8).
- ^{*4} You cannot copy playlists with a play time more than 8 hours.
- When you copy a playlist, it will become a title in the destination drive.
- ^{*5} **RAM -R DL +R DL +RW** : One title becomes one chapter.
-R -RW(V) +R : Chapters are created automatically (**-R -RW(V)** about 5-minutes **+R** about 8-minutes) when finalising after copying the disc.
- ^{*6} Thumbnails return to the default position.
- ^{*7} When copying playlists, the thumbnails may not reflect changes made to them.
- ^{*8} Possible only with titles on the HDD
[However it is not possible when copying with automatic finalisation or when copying SD Video from an SD card (**EX88**).]
- You cannot perform chasing play or edit, etc. while copying.
- You cannot play a playlist while copying titles with "One time only recording" restriction (⇒ 20).
- Still pictures or music cannot be played.

■ Approximate copying times (Max. speed)

(excludes time required to write data management information)

HDD		5X Speed DVD-RAM		12X Speed DVD-R ^{*1}		4X Speed DVD-R DL ^{*2}		4X Speed DVD-RW ^{*3}		8X Speed +R ^{*4}		4X Speed +R DL ^{*2}		4X Speed +RW		
Recording Mode	Recorded	Required time	Speed	Required time	Speed	Required time	Speed	Required time	Speed	Required time	Speed	Required time	Speed	Required time	Speed	
XP	1 hour	12 min.	5x	5 min. 46 s.	10x	15 min.	4x	15 min.	4x	8 min. 20 s.	7x	15 min.	4x	15 min.	4x	
SP		6 min.	10x	2 min. 30 s.	24x	7 min. 30 s.	8x	7 min. 30 s.	8x	3 min. 45 s.	16x	7 min. 30 s.	8x	7 min. 30 s.	8x	
LP		3 min.	20x	1 min. 21 s.	44x	3 min. 45 s.	16x	3 min. 45 s.	16x	1 min. 53 s.	32x	3 min. 45 s.	16x	3 min. 45 s.	16x	
EP (6H)		2 min.	30x	58 s.	62x	2 min. 30 s.	24x	2 min. 30 s.	24x							
EP (8H)		1 min. 30 s.	40x	48 s.	75x	1 min. 53 s.	32x	1 min. 57 s.	31x							

• The above values indicate the quickest possible times and speeds to high speed copy a one hour title recorded on the HDD to a high speed recording compatible disc. Depending on what part of the disc is being written to, the features of the disc, etc., the times and speeds will vary.

- ^{*1} In this unit, copying with a 16X Speed DVD-R disc will be performed at the same speed as with a 12X Speed DVD-R disc.
^{*2} In this unit, copying with 8X Speed discs, DVD-R DL and +R DL, will be performed at the same speed as with 4X Speed discs, DVD-R DL and +R DL.
^{*3} In this unit, copying with a 6X Speed DVD-RW disc will be performed at the same speed as with a 4X Speed DVD-RW disc.
^{*4} In this unit, copying with a 16X Speed +R disc will be performed at the same speed as with a 8X Speed +R disc.

Note

- When recording or playing while copying, the unit may not use the maximum recording speed.
- Depending on the condition of the disc, the unit may not copy using the maximum speed.

Regarding copying to DVD-R DL (single-sided, Dual Layer) and +R DL (single-sided, Double Layer)

When not copying in high speed mode, titles are temporarily copied at normal speed to the HDD and then copied at high speed to DVD-R DL and +R DL. The titles that were temporarily copied to the HDD are then deleted.

You cannot copy to DVD-R DL and +R DL in the following cases.

- When there is not enough free space on the HDD. (When copying to a new blank disc, if you intend to fill a new disc when copying to it, the equivalent of up to 4 hours of free space in SP mode is needed on the HDD.)
- When the number of titles recorded to the HDD and the number of titles to be copied to the DVD-R DL and +R DL is greater than 499 in total.

When playing a title recorded on both layers, video and audio may momentarily cut out when the unit is switching layers. (⇒ 10)

Regarding copying of the broadcasts that allow "One time only recording"

You can copy a recorded title to a CPRM (⇒ 84) compatible DVD-RAM, however, the title is deleted from the HDD.

- Titles or playlists cannot be copied from DVD-RAM to the HDD.
- Titles will not be copied if they are protected (⇒ 39).
- You cannot copy playlists created from "One time only recording" titles.
- Titles with recording limitations and playlists cannot be registered on the same copying list.

Before copying

When copying a title with main and secondary audio

- Select the audio type for recording bilingual broadcast from "Bilingual Audio Selection" (⇒ 62) when:
 - Copying to a DVD-R, DVD-R DL, DVD-RW (DVD-Video format), +R, +R DL and +RW.
 - When "Audio Mode for XP Recording" is set to "LPCM" (⇒ 62) and you are copying in XP mode.

■ Speed and recording mode when copying

HDD ↔ **RAM** : High speed

HDD → **-R -R DL -RW(V) +R +R DL +RW** : Refer to the following table.

Rec for High Speed Copy (⇒ 61)	Copy speed
Only titles recorded with "Rec for High Speed Copy" set to "On". *	High speed
Only titles recorded with "Rec for High Speed Copy" set to "Off".	Normal speed
When making a copy of multiple titles that were recorded with "Rec for High Speed Copy" set to "On" and "Off".	

* In the following cases, even if "Rec for High Speed Copy" is set to "On", copy will perform at normal speed.

- **+R +R DL +RW** When the copying source was recorded in "EP" or "FR (recordings 5 hours or longer)" mode.
- When the copy destination (disc) does not have enough space.
- When the title aspect for the copying source and "Aspect for Recording" do not match.
- When the title aspect for the copying source is 16:9:
 - **+R +R DL +RW**
 - **-R -R DL -RW(V)** copying source was recorded in "EP" or "FR (recordings 5 hours or longer)" mode.

Note

Titles and playlists recorded using a different encoding system (PAL or NTSC) from the TV system currently selected on the unit cannot be copied.

Preparation

- Insert a disc that you can use for copying (⇒ 10).
- Confirm that there is enough remaining disc space.

Copy

DVD-R, DVD-R DL, DVD-RW (DVD-Video format), +R and +R DL are automatically finalised (⇒ 84). After finalising, the discs become play-only and you can also play them on other DVD equipment. However, you can no longer record or edit.

HDD → **RAM -R -R DL -RW(V) +R +R DL +RW**

(You cannot copy to finalised discs.)

When copying in normal speed, recording mode will be set to FR. (However, if there is still not enough space after setting to FR mode, copy will not be performed.)

- 1 While stopped**
Press [FUNCTION MENU].
- 2 Press [▲, ▼] to select "Copy" and press [OK].**

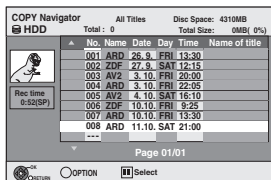

- 3 Press [▲, ▼] to select the title you want to copy and press [II].**
A check mark is displayed. Repeat this step until you select all necessary items.
• Press [II] again to cancel.

To show other pages

Press [◀, ▶] to show other pages.

- 4 Press [OK].**

- 5 After you start copying DVD-R, DVD-R DL, DVD-RW (DVD-Video format), +R and +R DL discs, they become play-only and you can no longer record or edit. Press [◀, ▶] to select "Start" and press [OK].**

Copy starts.

To return to the previous screen
Press [RETURN].

- **To stop copying (⇒ 47)**
 - **COPY Navigator/Copying list icons and functions (⇒ 48)**
 - **To check the properties of a title and sort COPY Navigator**
- 1 Press [▲, ▼] to select the title and press [OPTION].**

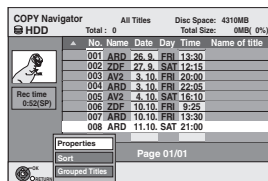

- 2 Press [▲, ▼] to select "Properties" or "Sort" and press [OK].**

Properties:

The name, recording date, channel etc. of the selected title are shown.

Sort (All Titles screen only):

Press [▲, ▼] to select the item and press [OK].

This changes the way that titles are displayed. You can select to display titles by No., recording date, day, channel, recording start time and title name. (You cannot select a title if it has a check mark.) If you close the COPY Navigator screen, the display order is cancelled.

Note

- When copying titles in high speed mode to high speed recording compatible DVD-RAM 5X, DVD-R 8X, +R 8X or +RW 4X, the sound of the disc rotating becomes louder than normal.
If you want copy to perform more quietly, select "Normal (Silent)" in "DVD Speed for High Speed Copy" in the Setup menu (⇒ 61).
- If you register multiple titles, they are copied in order from the title at the top of the screen and not in the order you registered them.
To change the order that titles are copied, create a copying list and then copy the contents of the list (⇒ 47).

Copying using the copying list— Advanced Copy

HDD ↔ RAM +RW
 -RW(VR) → HDD
 HDD → -R -R DL -RW(V) +R +R DL
 SD → HDD RAM

You can order titles and playlists as desired for copy to disc.

See also “Before copying” (⇒ 46).

- 1 While stopped
Press [FUNCTION MENU].
- 2 Press [▲, ▼] to select “To Others” and press [OK].
- 3 Press [▲, ▼] to select “Advanced Copy” and press [OK].

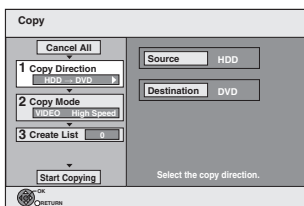

- If you are not going to change the registered list press [▼] several times (⇒ step 7).

4 Set the copy direction.

- If you are not going to change the copying direction, press [▼] (⇒ step 5).
- ① Press [▲, ▼] to select “Copy Direction” and press [▶].
- ② Press [▲, ▼] to select “Source” and press [OK].
- ③ Press [▲, ▼] to select the drive and press [OK].
If you select “HDD”, “Destination” is automatically set to “DVD”, or vice versa. (⇒ Go to step ⑥)
- ④ Press [▲, ▼] to select “Destination” and press [OK].
- ⑤ Press [▲, ▼] to select the drive and press [OK].
The same drive as the copy source cannot be selected.
- ⑥ Press [◀] to confirm.

5 Set the recording mode.

- If you are not going to change the recording mode, press [▼] (⇒ step 6).
- ① Press [▲, ▼] to select “Copy Mode” and press [▶].
- ② Press [▲, ▼] to select “Format” and press [OK].
- ③ Press [▲, ▼] to select “VIDEO” and press [OK].
- ④ Press [▲, ▼] to select “Recording Mode” and press [OK].
- ⑤ Press [▲, ▼] to select the mode and press [OK].
- ⑥ Press [◀] to confirm.

6 Register titles and playlists for copy.

- If you are going to copy a registered list without making any changes to it (⇒ step 7).
- ① Press [▲, ▼] to select “Create List” and press [▶].

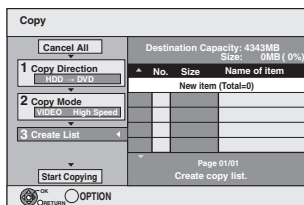

- ② Press [▲, ▼] to select “New item” and press [OK].
- ③ Press the “Red” button to select “VIDEO” or press the “Green” button to select “Playlists”.

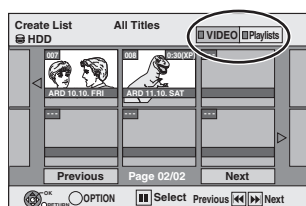

- ④ Press [▲, ▼, ◀, ▶] to select the title or playlist and press [■].

A check mark is displayed. Repeat this step until you select all necessary items.
 • Press [■] again to cancel.

- The items will be copied in the order of the copying list. If you want to specify the order, repeat selecting one item at a time.
- When you switch between the “VIDEO” and “Playlists” tab, the check mark is cancelled.
- When copying to a disc using high speed mode,
-R -R DL -RW(V) : only items indicated with “▶▶▶” or “▶▶▶!” can be registered.

+R +R DL +RW : only items indicated with “▶▶▶” can be registered.

- To show other pages (⇒ below)

⑤ Press [OK].

- To edit the copying list (⇒ 48)

You cannot start copying when the value of the “Size” (⇒ 48) exceeds 100% (“Destination Capacity” is not sufficient).

⑥ Press [◀] to confirm.

7 Press [▲, ▼] to select “Start Copying” and press [OK].

When copying titles in high speed mode to high speed recording compatible DVD-RAM 5X, DVD-R 8X, +R 8X or +RW 4X, the sound of the disc rotating becomes louder than normal.

If you want copy to perform more quietly, select “Normal (Silent)” in “DVD Speed for High Speed Copy” in the Setup menu (⇒ 61).

8 Press [◀, ▶] to select “Yes” and press [OK] to start copying.

HDD → +R -R DL -RW(V) +R +R DL
 Press [◀, ▶] to select “Copy & Finalise” or “Copy Only” and press [OK].

- If “Copy & Finalise” is selected

After finalising, the discs become play-only and you can also play them on other DVD equipment. However, you can no longer record or edit.

To show other pages
 Press [▲, ▼, ◀, ▶] to select “Previous” or “Next” and press [OK].
 • You can also press [◀◀, ▶▶] to show other pages.

■ To stop copying

Press and hold [RETURN] for 3 seconds.
 (You cannot stop while finalising)

When High-speed copying

All titles that have completely copied at the point cancelled are copied.

When Normal Speed copying

Copies until the point cancelled. However titles with “One time only recording” restriction, only titles that have completely copied at the point cancelled are copied to the disc. Titles that are cancelled before the copy is complete are not copied and remain on the HDD.

- **-R DL +R DL** If copy is cancelled during the step while temporarily copying to the HDD, then nothing will be copied. However, if copy is cancelled during the step while copying to disc from the HDD, then only titles completely copied at the point canceled are copied.

Even if the title was not copied to the DVD-R, DVD-R DL, DVD-RW (DVD-Video format), +R, +R DL or +RW, the amount of remaining writable disc space becomes less.

■ To return to the previous screen

Press [RETURN].

■ Recording and playing while copying

You can record and play using the HDD while high speed copying. (Only when high speed copying without finalising)

- Still pictures and music recorded on the HDD cannot be played. Press [OK] to cancel the screen display.

• To confirm the current progress









Press [STATUS ⓘ].

Note

- Timer recordings executed while copying are recorded to the HDD regardless of the recording drive settings. (Only when high speed copying without finalising)

COPY Navigator/Copying list icons and functions

COPY Navigator/Copying list indicators

-  Titles and playlists that can be copied in high speed mode to DVD-R, DVD-R DL, DVD-RW (DVD-Video format), +R, +R DL, +RW
-  Titles and playlists that can be copied in high speed mode to DVD-R, DVD-R DL, DVD-RW (DVD-Video format) (However, titles and playlists cannot be copied in high speed mode to +R, +R DL, +RW)
 - +R DL**  is displayed, but copy cannot be performed.
-  Title with "One time only recording" restriction (⇒ 20, When recording the "One time only recording" broadcasts)
-  Titles deleted from the HDD by "One time only recording" restriction after copying. (⇒ 20, When recording the "One time only recording" broadcasts)
-  Title or playlist contains still picture(s)
 - Still picture(s) cannot be copied.
-  (NTSC)
-  (PAL)
 - Titles and playlists displaying these marks cannot be selected.

Data size of each registered item

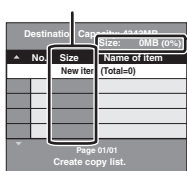

- Size:**
Data size recorded to the copy destination
- When copying at normal speed, the total data size will change according to the recording mode.
 - The total data size shown may be larger than the sum of the data sizes for each registered item, because of data management information being written to the copy destination, etc.

To play DVD-R, DVD-R DL, DVD-RW (DVD-Video format), +R and +R DL on other players, it is necessary to finalise them after copy.

To edit the copying list

Select the item in step 6-5 (⇒ 47)

- 1 Press [OPTION].
- 2 Press [▲, ▼] to select the operation and press [OK].

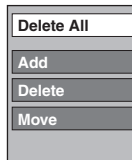

Delete All:

Delete all items registered on the copying list. Press [◀, ▶] to select "Yes" and press [OK].

Add:

Add new items to the copying list.

- 1 Press [▲, ▼, ◀, ▶] to select the title or playlist and press [III]. A check mark is displayed. Repeat this step until you select all necessary items.
 - Press [III] again to cancel.
- 2 Press [OK].

Delete:

Delete the selected items. Press [◀, ▶] to select "Yes" and press [OK].

Move:

Move selected items or change the order of items on the copying list. Press [▲, ▼] to select the destination and press [OK].

To cancel all registered copying setting and lists

After performing steps 1-3 (⇒ 47)

- 1 Press [▲, ▼] to select "Cancel All" and press [OK].
 - 2 Press [◀, ▶] to select "Yes" and press [OK].
- The settings and lists may be cancelled in the following situations.
 - When a title, still picture, etc. has been recorded or deleted at the copy source
 - When steps have been taken, for instance, to turn off the unit, open the tray, change the copy direction, etc.

Copying a finalised DVD-R, DVD-R DL, DVD-RW (DVD-Video format), +R and +R DL

DVD-V → HDD

You can copy the content of finalised DVD-R, DVD-R DL, DVD-RW (DVD-Video format), +R, and +R DL to the HDD and re-edit. While playing a disc, the content being played is copied to the HDD according to the set time.

- If you perform search, frame-by-frame or pause while copying, that portion of title is not recorded.
- When "Rec for High Speed Copy" (⇒ 61) is set to "On" and you make a copy, the copy will be made using the picture size selected in "Aspect for Recording" (⇒ 61) of the Setup menu.

Operations and on screen displays during copy are also recorded.

- Almost all DVD-Video on sale have been treated to prevent illegal copying, and cannot be copied.
- The following cannot be copied: Video CD, Audio CD and so on.

Preparation

- Insert the finalised disc (⇒ 14).

After performing steps 1-5 ("Format" is automatically set to "DVD-Video") (⇒ 47, Copying using the copying list-Advanced Copy)

1 Set "Copy Time".

- If you are not going to change the setting (⇒ step 2).

Setting the unit to copy according to the set time

- 1 Press [▲, ▼] to select "Copy Time" and press [▶].
- 2 Press [▲, ▼] to select "Time Setting" and press [OK].
- 3 Setting the unit to copy all the content on the disc
 - 3 Press [▲, ▼] to select "Off" and press [OK].
 - 4 Press [◀] to confirm. Copy will continue until there is not enough available recording space on the HDD.
- 5 Setting the copying time
 - 3 Press [▲, ▼] to select "On" and press [OK].
 - 4 Press [▲, ▼] to select "Copy Time" and press [OK].

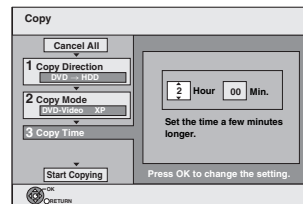

- 5 Press [◀, ▶] to select "Hour" and "Min." and press [▲, ▼] to set the recording time.
- 6 Press [OK].
- 7 Press [◀] to confirm. Copying to the HDD continues for the set time even after the content being played finishes.

- Set a few minutes longer than the source title, in order to include the operation time before play begins.
- You can also set the recording time with the numbered buttons.

2 Press [▲, ▼] to select "Start Copying" and press [OK].

Press [◀, ▶] to select "Yes" and press [OK] to start copying. The disc top menu is displayed.

- Disc play automatically begins from title 1 when "Title 1" is selected from the "Auto-Play Select" menu when finalising the disc (⇒ 58).

- 3** When the top menu is displayed
Press [**▲**, **▼**, **◀**, **▶**] to select the title you want to start copying, and press [**OK**].

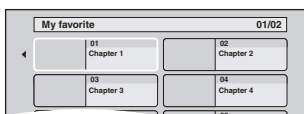

While playing in order, all the titles after the selected title are recorded until the set time. (After the last title on the disc has finished playing the top menu is recorded until the set time is reached.)

To return to the previous screen

Press [**RETURN**].

To stop copying

Press [**■**].

You can also press and hold [**RETURN**] for 3 seconds to stop copying.

- If stopped partway, copying will be up to that point.

Note

- The screen on the right is recorded at the beginning.
- The content is recorded as 1 title from the start of copy to the end.
- If play does not begin automatically or if the top menu does not display automatically, press [**▶**] (PLAY) to start.
- Even if you copy a high quality video/audio DVD, the original picture and audio quality cannot be exactly replicated.
- If you want to copy a title from a finalised DVD-RW (DVD Video Recording format), create a copy list and then copy (⇒ 47, Copying using the copying list–Advanced Copy).



Copying SD Video from an SD card

EX88

Motion pictures encoded in the MPEG2 format, which have been taken by a Panasonic SD Video Camera, digital video camera etc, can be stored on HDD or DVD-RAM.

(All the recordings on the same date become a title.)

- You cannot playback SD Video on an SD card with this unit. You must copy the files to the HDD or a DVD-RAM.
- You cannot playback or record while copying SD Video.
- This unit cannot copy AVCHD format motion pictures from an SD card.

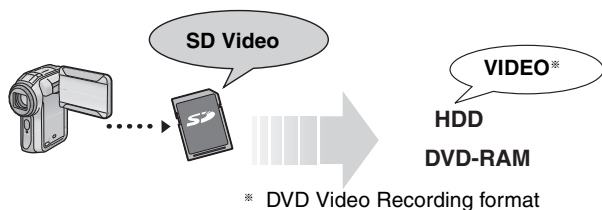

Copying SD Video from a video equipment **EX88**

Motion pictures encoded in the MPEG2 format, which have been taken by a Panasonic digital video camera with HDD etc, can be copied from the camera's HDD to this unit's HDD or DVD-RAM. (All the recordings on the same date become a title.)

- You cannot playback SD Video in the camera's HDD with this unit. You must copy the files to the HDD or a DVD-RAM.
- You cannot playback or record while copying SD Video.

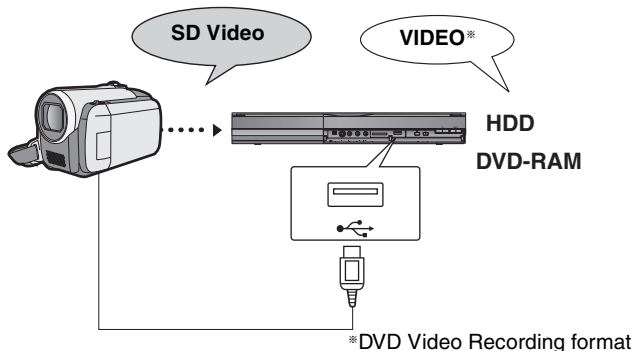

Preparation

- 1 Turn on both this unit and the camera.
 - 2 Connect the camera to this unit.
 - 3 Select the appropriate mode that makes the camera ready for data transfer (such as "PC CONNECT") on the camera.
- Refer to the camera's operating instructions for detail.

The display below automatically appears when you connect the camera to this unit.

Press [**▲**, **▼**] to select "Copy Video (MPEG2)" and press [**OK**]. Then go to step 7 on page 47.

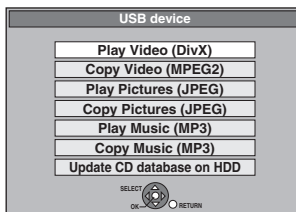

- SD Video on the camera are automatically registered on the copy list.
- If there are no SD Video on the camera, "Copy Video (MPEG2)" is not displayed.

The display below automatically appears when you insert a card into the SD card slot while stopped.

Press [**▲**, **▼**] to select "Copy Video (MPEG2)" and press [**OK**]. Then go to step 7 on page 47.

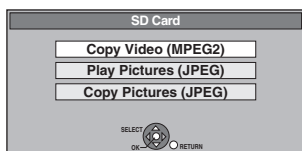

How to copy

Refer to "Copying using the copying list–Advanced Copy" (⇒ 47) Please set the items in step 4 and 5 as shown below.

Copy Direction:

Source:SD CARD

Copy Mode:

Format:VIDEO

- SD Video on an SD card are automatically registered on the copy list.
- If there are no SD Video on an SD card, "Copy Video (MPEG2)" is not displayed.

Copying still pictures

Instructions/notes regarding SD cards and SD drive are applicable to the DMR-EX88 model only.

HDD RAM USB SD

- SDHC Memory Cards used for recording with this unit can only be used with other SDHC Memory Card-compatible equipment. SDHC Memory Cards cannot be used with equipment that is only compatible with SD Memory Cards.
- You cannot copy pictures recorded to CD-R/CD-RW.
- Still pictures copied from USB memories or SD cards are grouped by the shooting date in the HDD or DVD-RAM.

Copying all the still pictures on the USB memory—Copy All Pictures

USB → HDD or RAM

- 1 While stopped
Insert the USB memory (⇒ 14).
The menu is automatically displayed.

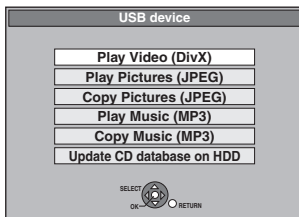

- 2 Press [▲, ▼] to select “Copy Pictures (JPEG)” and press [OK].

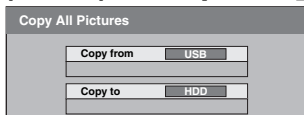

- 3 Press [▲, ▼] to select “Copy to” and press [◀, ▶] to select the drive.
- 4 Press [▲, ▼, ▶, ▶] to select “Copy” and press [OK].

To stop copying

Press and hold [RETURN] for 3 seconds.

To return to the previous screen

Press [RETURN].

Note

- The structure of folders on the USB memory may not be the same at the copy destination.
- If the space on the destination drive runs out or the number of files/folders to be copied exceeds the maximum (⇒ 13), copying will stop partway through.
- You cannot copy the information about the picture rotation.

Copying new still pictures on the SD card—Copy New Pictures EX88

SD → HDD or RAM

This unit saves information about imported still pictures. Therefore, if still pictures are imported from the same SD card, then only new still pictures will be imported.

- 1 While stopped
Insert the SD card. (⇒ 14).
The menu is automatically displayed.

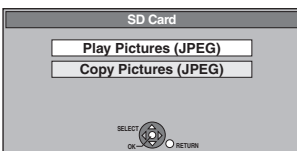

- 2 Press [▲, ▼] to select “Copy Pictures (JPEG)” and press [OK].

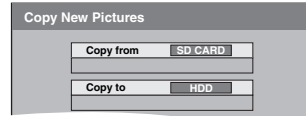

- 3 Press [▲, ▼] to select “Copy to” and press [◀, ▶] to select the drive.
- 4 Press [▲, ▼, ▶, ▶] to select “Copy” and press [OK].

To stop copying

Press and hold [RETURN] for 3 seconds.

To return to the previous screen

Press [RETURN].

Note

- This unit saves the information on up to 12,000 still pictures and 30 SD cards. If additional still pictures are imported, then the older information will be deleted.
- If the space on the destination drive runs out or the number of files/folders to be copied exceeds the maximum (⇒ 13), copying will stop partway through.
- You cannot copy the information about the picture rotation.

Copying using the copying list

HDD RAM SD

- 1 While stopped
Press [FUNCTION MENU].
- 2 Press [▲, ▼] to select “To Others” and press [OK].
- 3 Press [▲, ▼] to select “Advanced Copy” and press [OK].

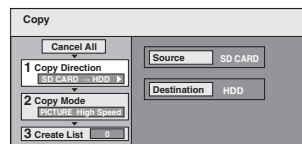

- If you are not going to change the registered list press [▼] several times (⇒ step 7).

- 4 Set the copy direction.

- If you are not going to change the copying direction, press [▼] (⇒ step 5).

- ① Press [▲, ▼] to select “Copy Direction” and press [▶].
- ② Press [▲, ▼] to select “Source” and press [OK].
- ③ Press [▲, ▼] to select the drive and press [OK].
- ④ Press [▲, ▼] to select “Destination” and press [OK].
- ⑤ Press [▲, ▼] to select the drive and press [OK].
The same drive as the copy source can be selected.
- ⑥ Press [◀] to confirm.

- 5 Set the copy mode.

- If you are not going to change the recording mode, press [▼] (⇒ step 6).

- ① Press [▲, ▼] to select “Copy Mode” and press [▶].
- ② Press [▲, ▼] to select “Format” and press [OK].
- ③ Press [▲, ▼] to select “PICTURE” and press [OK].
“Recording Mode” is automatically set to “High Speed”.
- ④ Press [◀] to confirm.

6 Register still pictures for copy.

- If you are going to copy a registered list without making any changes to it (⇒ step 7).

You can register still pictures or still picture folders.

- Still pictures and folders cannot be registered on the same list.

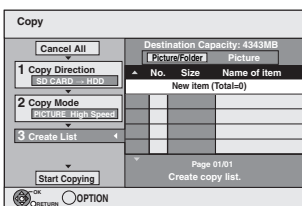

■ To register individual still pictures

- 1 Press [▲, ▼] to select “Create List” and press [▶].
- 2 Press [▲, ▼] to select “New item” and press [OK].
- 3 Press [▲, ▼, ◀, ▶] to select the still picture and press [■].

A check mark is displayed. Repeat this step until you select all necessary items.

- Press [■] again to cancel.

- The items will be copied in the order of the copying list. If you want to specify the order, repeat selecting one item at a time.

- To show other pages (⇒ right)
- To select another folder (⇒ right)

- 4 Press [OK].

- To edit the copying list (⇒ right)

- 5 Press [◀] to confirm.

■ To register on a folder by folder basis

- 1 Press [▲, ▼] to select “Create List” and press [▶].
- 2 Press [▲, ▼] to select “Picture/Folder” and press [OK].



- 3 Press [▲, ▼] to select “Folder” and press [OK].
- 4 Press [▲, ▼] to select “New item” and press [OK].
- 5 Press [▲, ▼] to select the folder and press [■].

A check mark is displayed. Repeat this step until you select all necessary items.

- Press [■] again to cancel.

- The items will be copied in the order of the copying list. If you want to specify the order, repeat selecting one item at a time.

- To show other pages (⇒ right)

- 6 Press [OK].

- To edit the copying list (⇒ right)

- 7 Press [◀] to confirm.

7 Press [▲, ▼] to select “Start Copying” and press [OK].

- Only when copying individual still pictures from **HDD** **RAM** to **SD**

When specifying another folder as the copying destination, select “Folder”.

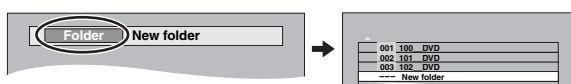

8 Press [◀, ▶] to select “Yes” and press [OK] to start copying.

To stop copying

Press and hold [RETURN] for 3 seconds.

To return to the previous screen

Press [RETURN].

Note

- The sequence in which the still pictures are registered on the copy list may not be the same at the copy destination.
- If still pictures are already contained inside the copy destination folder, the new still pictures are recorded following the existing still pictures.
- If the space on the destination drive runs out or the number of files/folders to be copied exceeds the maximum (⇒ 13), copying will stop partway through.
- You cannot copy the information about the picture rotation.

To show other pages

Press [▲, ▼, ◀, ▶] to select “Previous” or “Next” and press [OK].

- You can also press [◀◀, ▶▶] to show other pages.

■ To edit the copying list

Select the item in step 6–④ (for a still picture) or 6–⑥ (for a folder) (⇒ left)

- 1 Press [OPTION].
- 2 Press [▲, ▼] to select the operation and press [OK].

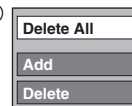

Delete All:

Delete all items registered on the copying list.

Press [◀, ▶] to select “Yes” and press [OK].

Add:

Add new items to the copying list.

- 1 Press [▲, ▼, ◀, ▶] to select the still picture or folder and press [■].

A check mark is displayed. Repeat this step until you select all necessary items.

- Press [■] again to cancel.

- 2 Press [OK].

Delete:

Delete the selected items.

Press [◀, ▶] to select “Yes” and press [OK].

To cancel all registered copying settings and lists

After performing steps 1–3 (⇒ 50, Copying using the copying list)

- 1 Press [▲, ▼] to select “Cancel All” and press [OK].
- 2 Press [◀, ▶] to select “Yes” and press [OK].

- The settings and lists may be cancelled in the following situations.

– When a title or still picture has been recorded or deleted at the copy source

– When steps have been taken, for instance, to turn off the unit, remove the card, open the tray, change the copy direction, etc.

■ To select another folder

After performing steps 6–② (⇒ left, To register individual still pictures)

- 1 Press [▲, ▼, ◀, ▶] to select “Folder” and press [OK].
- 2 Press [▲, ▼] to select the folder and press [OK].

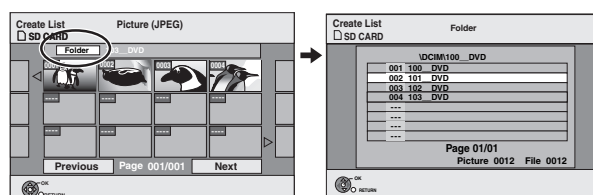

You can also select folders with the numbered buttons.

e.g.,

5: [0] ⇒ [0] ⇒ [5]

15: [0] ⇒ [1] ⇒ [5]

115: [1] ⇒ [1] ⇒ [5]

- The still pictures of different folders cannot be registered on the same list.

Copying music to HDD

You can store the two formats of music data in this unit's HDD.

Music CD (CD-DA)

When copying music CDs, this unit makes access to the internal Gracenote® Database to obtain title information. The album name, track name and artist name are assigned automatically allowing you find the track easily when playing back.

MP3

You can copy MP3 files from the USB memory.

About the Gracenote® Database

The Gracenote® Database is a database used to search and retrieve CD title information.

When a CD is inserted or recording from a CD begins, the unit will automatically search for and obtain information about the inserted CD.

The Gracenote® Database comes pre-installed on this unit, so titles and artist information can be obtained. Please note however that the newest CD titles, etc. may not be registered yet to the internal database. This unit has an internal database containing information for approximately 350,000 album titles.

You can update the internal database (⇒ 53).

If there are CDs with very similar title information, then the incorrect title information may be obtained. If no title suggestions are found, then track name, album name and artist name will be blank. In these cases, enter the CD title information manually, after recording to the HDD has completed.

Copying music from a CD

CD → HDD

All tracks on the music CD (CD-DA) are recorded on the HDD. (Cannot record track-by-track.)

- One CD is recorded on the HDD as one album.
- Audio quality: LPCM
- The maximum number of albums on HDD: 300 (Depends on the remaining capacity.)
If titles or pictures are recorded, then the number of albums that can be recorded will be reduced.

Preparation

Press [DRIVE SELECT] to select the DVD drive.

1 Insert a music CD.

The menu is automatically displayed.

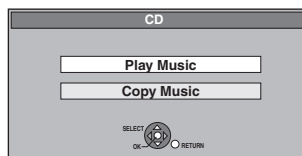

2 Press [▲, ▼] to select “Copy Music” and press [OK].

The unit starts accessing the Gracenote® Database and searches for the title information.



If search results indicate that multiple titles were found Press [▲, ▼] to select the appropriate title and press [OK].

3 Press [◀, ▶] to select “Copy” and press [OK].

Recording starts.

To stop recording

Press and hold [RETURN] for 3 seconds.

- If the recording is cancelled, then no tracks on the CD will be recorded.

To return to the previous screen

Press [RETURN].

Note

- While recording, no other operations can be performed. Timer recordings will not proceed.
- Tracks recorded on the HDD cannot be transferred to a disc, USB memory or SD card.
- CDs which have SCMS (Serial Copy Management System) restrictions cannot be recorded to the HDD.

Copying music from a USB memory

USB → HDD

You can copy MP3 files recorded on USB memory devices to the HDD by file or folder.

- One folder is recorded on the HDD as one group.
- The maximum number of groups on HDD: 300
The maximum number of tracks on HDD: 3000 (Depends on the remaining capacity.)
If titles or pictures are recorded, then the number of groups that can be recorded will be reduced.

1 While stopped Insert the USB memory (⇒ 14).

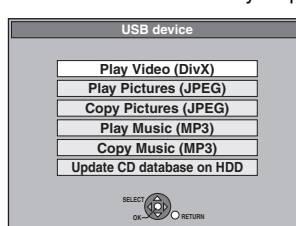

2 Press [▲, ▼] to select “Copy Music (MP3)” and press [OK].

“Copy Direction” and “Copy Mode” are automatically set to “USB→HDD” and “MUSIC High Speed”, respectively.

3 Register MP3 files for copy.

- If you are going to copy a registered list without making any changes to it (⇒ step 4).

You can register MP3 files or MP3 file folders.

- MP3 files and folders cannot be registered on the same list.

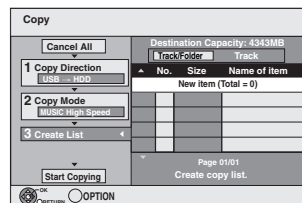

■ To register individual MP3 files

- 1 Press [▲, ▼] to select “Create List” and press [▶].
- 2 Press [▲, ▼] to select “New item” and press [OK].
- 3 Press [▲, ▼] to select the folder and press [OK].
- 4 Press [▲, ▼] to select the MP3 file and press [■].
A check mark is displayed. Repeat this step until you select all necessary items.
 - Press [■] again to cancel.
 - The items will be copied in the order of the copying list. If you want to specify the order, repeat selecting one item at a time.
- 5 Press [OK].
 - To edit the copying list (⇒ 53)
- 6 Press [◀] to confirm.

■ To register on a folder by folder basis

- ① Press [▲, ▼] to select “Create List” and press [▶].
- ② Press [▲, ▼] to select “Track/Folder” and press [OK].



- ③ Press [▲, ▼] to select “Folder” and press [OK].
- ④ Press [▲, ▼] to select “New item” and press [OK].
- ⑤ Press [▲, ▼] to select the folder and press [■].
A check mark is displayed. Repeat this step until you select all necessary items.
 - Press [■] again to cancel.
 - The items will be copied in the order of the copying list. If you want to specify the order, repeat selecting one item at a time.
- ⑥ Press [OK].
 - To edit the copying list (⇒ below)
- ⑦ Press [◀] to confirm.

4 Press [▲, ▼] to select “Start Copying” and press [OK].

- For individual files only
- When specifying an existing folder as the copying destination**

- ① Press [▲, ▼] to select “Folder” and press [OK].
- ② Press [▲, ▼] to select the folder and press [OK].

When creating a new folder as the copying destination

- ① Press [◀, ▶] to select “Yes” and press [OK].
- ② Enter the folder name (⇒ 44, Entering text).

5 Press [◀, ▶] to select “Yes” and press [OK] to start copying.

To stop copying

Press and hold [RETURN] for 3 seconds.

To return to the previous screen

Press [RETURN].

Note

- The sequence in which the MP3 files are registered on the copy list may not be the same at the copy destination.
- If MP3 files are already contained inside the copy destination folder, the new MP3 files are recorded following the existing MP3 files.

■ To edit the copying list

Select the item in step 3–⑤ (for a MP3 file) (⇒ 52, Copying music from a USB memory) or 3–⑥ (for a folder) (⇒ above).

- ① Press [OPTION].
- ② Press [▲, ▼] to select the operation and press [OK].

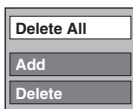

Delete All:

Delete all items registered on the copying list.
Press [◀, ▶] to select “Yes” and press [OK].

Add:

Add new items to the copying list.

- 1 Press [▲, ▼] to select the MP3 file or folder and press [■].
A check mark is displayed. Repeat this step until you select all necessary items.
 - Press [■] again to cancel.
- 2 Press [OK].

Delete:

Delete the selected items.
Press [◀, ▶] to select “Yes” and press [OK].

To cancel all registered copying settings and lists

After performing steps 1–2 (⇒ 52, Copying music from a USB memory)

- 1 Press [▲, ▼] to select “Cancel All” and press [OK].
 - 2 Press [◀, ▶] to select “Yes” and press [OK].
- The settings and lists may be cancelled in the following situations.
 - When a file has been recorded or deleted at the copy source
 - When steps have been taken, for instance, to turn off the unit, remove the USB memory, open the tray, change the copy direction, etc.

Note

- If the space on the destination drive runs out or the number of files/folders to be copied exceeds the maximum (⇒ 13), copying will stop partway through.

To update the Gracenote® Database

To update the database with information on CDs that were recently released, follow the instructions below.

■ Preparing the update data

- 1 Visit the following website.
<http://panasonic.net/pavc/support/gn/>
- 2 Download the data to your USB memory.
 - USB memory 1 GB or larger is required.
 - Refer to the instruction on the website for more information.

■ Updating the database on this unit

- 3 Turn on this unit.
- 4 Insert the USB memory (⇒ 14).
The menu is automatically displayed.

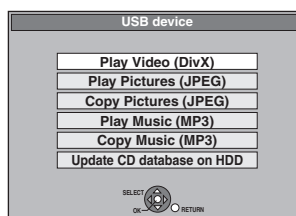

- 5 Press [▲, ▼] to select “Update CD database on HDD” and press [OK].
- 6 Press [◀, ▶] to select “Update” and press [OK].
 - Updating takes up to 20 minutes.
 - **Do not disconnect the USB memory and the AC mains lead while updating.**
 - **Once started, you cannot cancel updating.**
A message appears when updating is finished.
- 7 Press [OK].

Note

- Timer recordings do not start while updating.
- Updating overwrites the internal database forcibly regardless of whether the data in the USB memory is the latest or not. Make sure you download the latest version from the website.
- Some of the CD title information in the database may be deleted after updating the database.
- No name will be assigned after copying a CD to HDD if the CD title information of the CD is not registered in the database. Even if the CD title information of that CD is added to the database by updating later, the information will not be assigned to the track/album already copied on the HDD. (The names will be still blank.)
- Depending on the situation of Panasonic or Gracenote, upgrading the Gracenote® Database and providing it through the Web may be discontinued without notice.

Using on-screen menus

Common procedures

1 Press [DISPLAY].

Disc	Soundtrack	1	DD Digital	2/0 ch
Play	Subtitle		Off	
Picture	Audio channel		L R	
Sound				
Other				

- Depending on the condition of the unit (playing, stopped, etc.) and disc contents, there are some items that you cannot select or change.

2 Press [▲, ▼] to select the menu and press [▶].

3 Press [▲, ▼] to select the item and press [▶].

4 Press [▲, ▼] to select the setting.

- Some items can be changed by pressing [OK].

To clear the on-screen menus
Press [DISPLAY].

Disc menu—Setting the disc content

Soundtrack*

HDD RAM -R -R DL -RW(V) +R +R DL +RW -RW(VR)

The disc's audio attributes appear.

DVD-V

Select the audio and language (⇒ right, Audio attribute, Language).

DivX

Select the soundtrack number.

- Soundtrack numbers are displayed even when there is only one audio type.

Subtitle*

DVD-V

Turn the subtitle on/off and select the language (⇒ right, Language).

HDD RAM -R -R DL -RW(V) +R +R DL +RW -RW(VR) (Only discs that contain subtitle on/off information)

Turn the subtitle on/off.

- Subtitle on/off information cannot be recorded using this unit.

DivX

Turn the subtitle on/off and select the subtitle number.

- Subtitle numbers are displayed even if there are not multiple subtitles.

Angle* **DVD-V**

Change the number to select an angle.

Audio channel **HDD RAM -RW(VR) VCD** and DivX

(⇒ 28, Changing audio during play)

Source Select (DivX)

- **Automatic:**
The constructing method of the DivX contents is automatically distinguished and output.
- **Interlace:**
Select when the disc contents were recorded using interlace.
- **Progressive:**
Select when the disc contents were recorded using progressive.

PBC (Playback control ⇒ 84) **VCD**

Indicates whether menu play (playback control) is on or off.

- * With some discs, you may only be able to make changes using the menus (⇒ 16) on the disc.
- The display changes according to the disc content. You cannot change when there is no recording.

Audio attribute

LPCM/□□ Digital/DTS/MPEG:

k (kHz):

b (bit):

ch (channel):

Signal type

Sampling frequency

Number of bits

Number of channels

Language

ENG: English	DAN: Danish	THA: Thai
FRA: French	POR: Portuguese	POL: Polish
DEU: German	RUS: Russian	CES: Czech
ITA: Italian	JPN: Japanese	SLK: Slovak
ESP: Spanish	CHI: Chinese	HUN: Hungarian
NLD: Dutch	KOR: Korean	FIN: Finnish
SVE: Swedish	MAL: Malay	*: Others
NOR: Norwegian	VIE: Vietnamese	

Play menu—Change the play sequence

This function works only when the elapsed play time is displayed. Select the item for repeat play. Depending on the disc, the items that can be selected will differ.

Repeat Play

- All
- Chapter
- Group
- PL (Playlist)
- Title
- Track

CD VCD

HDD RAM -R -R DL -RW(V) +R +R DL

+RW DVD-V -RW(VR)

MP3 (except USB)

HDD RAM -RW(VR)

HDD RAM -R -R DL -RW(V) +R +R DL

+RW DVD-V -RW(VR)

CD VCD and MP3 (except USB)

Select "Off" to cancel.

Picture menu—Change the picture quality

Playback NR

Reduces noise and picture degradation.

Progressive* (⇒ 84)

Select "On" to enable progressive output.
Select "Off" if the picture is stretched horizontally.

Transfer* [When "Progressive" (⇒ above) is set to "On".]

Select the method of conversion for progressive output to suit the type of title being played (⇒ 84, Film and video).

When the output signal is PAL
(When the tray is opened, the setting will return to "Auto".)

- **Auto:** Automatically detects the film and video content, and appropriately converts it.
- **Video:** Select when using "Auto", and the content is distorted.
- **Film:** Select this if the edges of the film content appear jagged or rough when "Auto" is selected. However, if the video content is distorted as shown in the illustration to the right, then select "Auto".

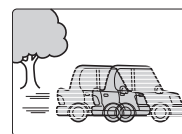

When the output signal is NTSC

- **Auto1 (normal):** Automatically detects the film and video content, and appropriately converts it.
- **Auto2:** In addition to "Auto1", automatically detects film contents with different frame rates and appropriately converts it.
- **Video:** Select when using "Auto1" and "Auto2", and the content is distorted.

Input NR

Reduces the noise while recording (Except analogue channels).

- **Automatic:**
Noise reduction only works on picture input from a video tape.
- **On:**
Noise reduction works for input video.
- **Off:**
Noise reduction is off. You can record the input signal as it is.

* Only when you have set "Progressive" to "On" in the Setup menu (⇒ 64).

Sound menu—Change the DVB multi audio and sound effect

DVB Multi Audio

[Digital channel only]

If more than one audio channel is output, you can set the desired channel before recording.

- DVB Multi Audio cannot be selected during playback or recording.
- Depending on the broadcast, the items that can be selected will differ.

- English
- Italian
- Spanish
- German
- French
- Original*

* "Original" is displayed when a broadcast is only available in the original language.

V.S.S.

HDD RAM -R -R DL -RW(V) +R +R DL +RW DVD-V -RW(VR)

(Dolby Digital, MPEG, 2-channel or over only)

Enjoy a surround-like effect if you are using two front speakers only.

- Turn V.S.S. off if it causes distortion. (Check the surround function on the connected equipment.)
- V.S.S. does not work for bilingual recordings.

Dialogue Enhancer

HDD RAM -R -R DL -RW(V) +R +R DL +RW DVD-V -RW(VR) and DivX

(Dolby Digital, 3-channel or over only, including a centre channel)

The volume of the centre channel is raised to make dialogue easier to hear.

Other menu—Change the DVB subtitle and display position

Position

1–5:

The higher the setting the lower the on-screen menu moves.

Status messages

Press [STATUS].

The display changes each time you press the button.

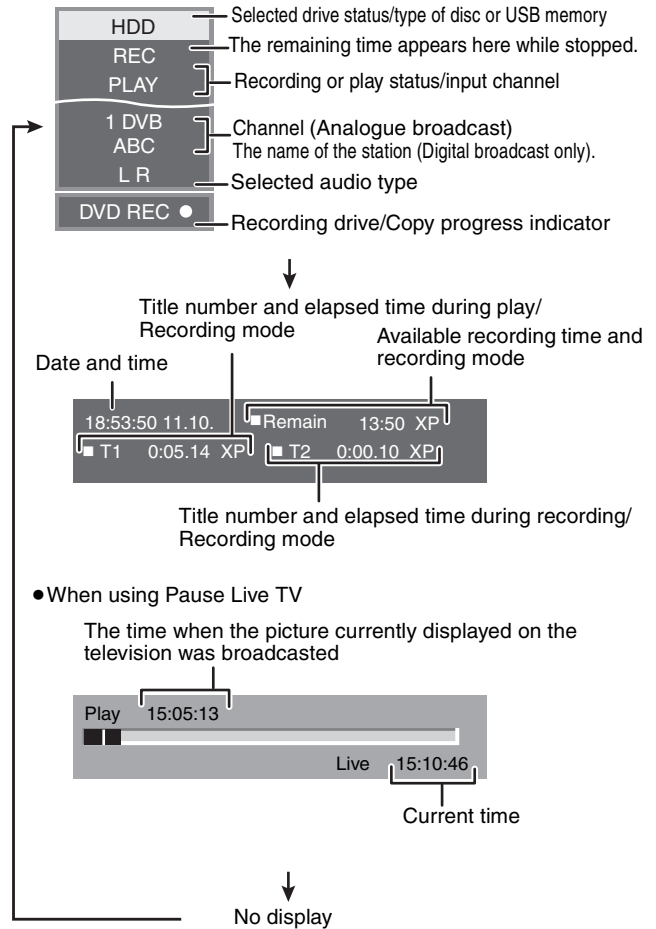

Instructions/notes regarding SD cards and SD drive are applicable to the DMR-EX88 model only.

HDD **RAM** **-R** **-R DL** **-RW(V)** **+R** **+R DL** **+RW** **-RW(VR)**
SD

Common procedures

Preparation

- Press [DRIVE SELECT] to select the drive.

- 1 While stopped
Press [FUNCTION MENU].
- 2 Press [▲, ▼] to select “To Others” and press [OK].

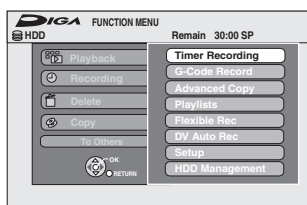

- 3 Press [▲, ▼] to select “HDD Management”, “DVD Management” or “Card Management” and press [OK].

e.g., **RAM**

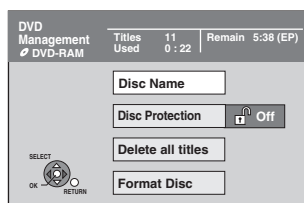

- When HDD has been selected, “Delete all titles” and “Format HDD” are displayed.
- When SD has been selected, “Format Card” only is displayed.

Setting the protection

RAM

Preparation

- Press [DRIVE SELECT] to select the DVD drive.

After performing steps 1–3 (⇒ left)

- 1 Press [▲, ▼] to select “Disc Protection” and press [OK].
- 2 Press [◀, ▶] to select “Yes” and press [OK].

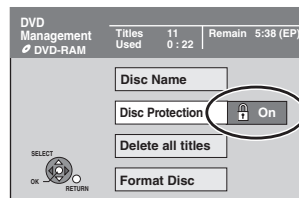

The lock symbol appears closed when the disc is write-protected.

To return to the previous screen

Press [RETURN].

To exit the screen

Press [EXIT].

Cartridge-protection

For a DVD-RAM with a cartridge

- With the write-protect tab in the protect position, play automatically starts when inserted in the unit.

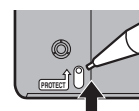

SD

Switch the write-protect switch to the “LOCK” position.



Providing a name for a disc

RAM **-R** **-R DL** **-RW(V)** **+R** **+R DL** **+RW**

You can provide a name for each disc.

Preparation

- Press [DRIVE SELECT] to select the DVD drive.
- **RAM** Release protection (⇒ above, Setting the protection).

After performing steps 1–3 (⇒ left)

- 1 Press [▲, ▼] to select “Disc Name” and press [OK].

(⇒ 44, Entering text)

- The disc name is displayed in the DVD Management window.
- **-R** **-R DL** **-RW(V)** **+R** **+R DL** With a finalised disc, the name is displayed on the Top Menu.
- **+RW** The disc name is displayed only if you play the disc on other equipment after creating top menu.



To return to the previous screen

Press [RETURN].

To exit the screen

Press [EXIT].

Deleting all titles and playlists—Delete all titles

HDD **RAM**

Preparation

- Press [DRIVE SELECT] to select the HDD or DVD drive.
- **RAM** Release protection (⇒ 56, Setting the protection).

After performing steps 1–3 (⇒ 56, Common procedures)

- 1 Press [**▲**, **▼**] to select “Delete all titles” and press [OK].
- 2 Press [**◀**, **▶**] to select “Yes” and press [OK].
- 3 Press [**◀**, **▶**] to select “Start” and press [OK].
A message appears when finished.
- 4 Press [OK].

To return to the previous screen

Press [RETURN].

To exit the screen

Press [EXIT].

Note

- **Once deleted, the recorded contents are lost and cannot be restored.** Make certain before proceeding.
- Deleting all video titles will result in all playlists also being deleted.
- Still picture data (JPEG), music data or computer data cannot be deleted.
- Delete does not work if one or more titles are protected.

Deleting all the contents—Format

HDD **RAM** **-RW(V)** **+RW** **-RW(VR)**

+R **+R DL** (New disc only)

SD

Preparation

- Press [DRIVE SELECT] to select the HDD, DVD or SD drive.
- **RAM** **SD** Release protection (⇒ 56, Setting the protection).

Note

Formatting deletes all contents (including computer data), and they cannot be restored. Check carefully before proceeding. The contents are deleted when you format a disc or card even if you have set protection.

After performing steps 1–3 (⇒ 56, Common procedures)

- 1 Press [**▲**, **▼**] to select “Format HDD”, “Format Disc” or “Format Card” and press [OK].
- 2 Press [**◀**, **▶**] to select “Yes” and press [OK].
- 3 Press [**◀**, **▶**] to select “Start” and press [OK].
A message appears when formatting is finished.
- 4 Press [OK].

Note

- Formatting normally takes a few minutes; however, it may take up to a maximum of 70 minutes (**RAM**).
- **Do not disconnect the AC mains lead while formatting.** This can render the disc or the card unusable.

Note

- When a disc or card has been formatted using this unit, it may not be possible to use it on any other equipment.
- **-R** **-R DL** **CD** Formatting cannot be performed.
- You can format DVD-RW only as DVD-Video format on this unit.

To stop formatting **RAM**

Press [RETURN].

- You can cancel formatting if it takes more than 2 minutes. The disc must be reformatted if you do this.

To return to the previous screen

Press [RETURN].

To exit the screen

Press [EXIT].

Selecting the background style—Top Menu

-R -R DL -RW(V) +R +R DL +RW

You can select the background that will be displayed as the DVD-Video top menu after finalising or creating Top Menu (**+RW**).

Preparation

Press [DRIVE SELECT] to select the DVD drive.

After performing steps 1–3 (⇒ 56, Common procedures)

- 1 Press [**▲**, **▼**] to select “Top Menu” and press [OK].
- 2 Press [**▲**, **▼**, **◀**, **▶**] to select the background and press [OK].

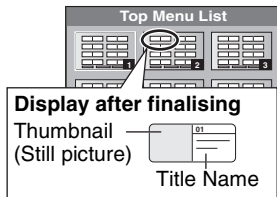

- You can change thumbnails displayed in the top menu. (⇒ 39, Change Thumbnail)

Selecting whether to show the Top Menu first—Auto-Play Select

-R -R DL -RW(V) +R +R DL +RW

You can select whether to show the top menu after finalising.

Preparation

Press [DRIVE SELECT] to select the DVD drive.

After performing steps 1–3 (⇒ 56, Common procedures)

- 1 Press [**▲**, **▼**] to select “Auto-Play Select” and press [OK].
- 2 Press [**▲**, **▼**] to select “Top Menu” or “Title 1” and press [OK].

Top Menu: The top menu appears first.
Title 1: The disc content is played without displaying the top menu.

Enabling discs to be played on other equipment—Finalise

-R -R DL -RW(V) +R +R DL

Make selections from “Top Menu” and “Auto-Play Select” (⇒ above) before finalising the disc.

Preparation

Press [DRIVE SELECT] to select the DVD drive.

After performing steps 1–3 (⇒ 56, Common procedures)

- 1 Press [**▲**, **▼**] to select “Finalise” and press [OK].
- 2 Press [**◀**, **▶**] to select “Yes” and press [OK].
- 3 Press [**◀**, **▶**] to select “Start” and press [OK].

A message appears when finalising is finished.

Note

- You cannot cancel finalising.
- Finalising takes up to 15 minutes.
- (**-R DL +R DL** Finalising takes up to 60 minutes.)
- Do not disconnect the AC mains lead while finalising. This will render the disc unusable.

- 4 Press [OK].

Note

When finalising a high-speed recording compatible disc, it may take longer than displayed on the confirmation screen (approximately four times).

After finalising

- **-R -R DL +R +R DL** The disc becomes play-only and you can no longer record or edit.
 - **-RW(V)** You can record and edit the disc after formatting (⇒ 57) although it becomes play-only after finalising.
 - When copying in high speed, chapters will be replicated.
 - **-R -RW(V)** Titles are divided into about 5-minute (**+R** 8-minute)* chapters, if
 - the titles were directly recorded to the disc.
 - the titles were copied using any mode other than the high speed mode (excluding **-R DL +R DL**).
- * This time varies greatly depending on the condition and mode of recording.
- There is a pause of several seconds between titles and chapters during play.

	Before finalising	After finalising
Recording/Editing/Entering name	○	–
Play on other players	–	○

- You cannot finalise discs recorded on other manufacturer’s equipment.
- If you finalise discs recorded on Panasonic equipment other than this unit, the background selected as “Top Menu” may not be displayed.
- Discs finalised on this unit may not be playable on other players due to the condition of the recording.

Creating Top Menu—Create Top Menu

+RW

+RW discs contain no Top Menu data. Top Menu is a convenient function. We recommend you create the menu before playing a +RW disc on other equipment.

You cannot use the Top Menu for playing on this unit.

Make selections from “Top Menu” and “Auto-Play Select” (⇒ left) before creating top menu.

Preparation

Press [DRIVE SELECT] to select the DVD drive.

After performing steps 1–3 (⇒ 56, Common procedures)

- 1 Press [**▲**, **▼**] to select “Create Top Menu” and press [OK].
- 2 Press [**◀**, **▶**] to select “Yes” and press [OK].
- 3 Press [**◀**, **▶**] to select “Start” and press [OK].
Creating Top Menu starts. You cannot cancel creating. Creating Top Menu can take a few minutes.
- 4 Press [OK].

Note

- You can record or edit discs after creating the Top Menu. But the created menu is deleted when you record or edit disc. In such cases, create the Top Menu again by using “Create Top Menu”.

To return to the previous screen

Press [RETURN].

To exit the screen

Press [EXIT].

Changing the unit's settings

You can change the unit's settings using Setup menu.
 • The settings remain intact even if you switch the unit to standby.

Common procedures

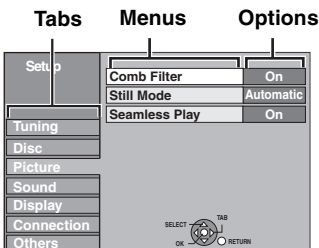
- 1** While stopped
Press [FUNCTION MENU].
 - 2** Press [▲, ▼] to select "To Others" and press [OK].
 - 3** Press [▲, ▼] to select "Setup" and press [OK].
- 
- 4** Press [▲, ▼] to select the tab and press [▶].
 - 5** Press [▲, ▼] to select the menu and press [OK].
 - 6** Press [▲, ▼] to select the option and press [OK].

To return to the previous screen
Press [RETURN].

To exit the screen
Press [EXIT].

Tuning

■ Edit Favourites

You can create four groups of channels for making viewing and recording easier. Editing these groups does not affect the channel setting itself.

- Timer recording may not work correctly if you edit the groups during timer recording standby.

Press the "Green" button to select the groups.

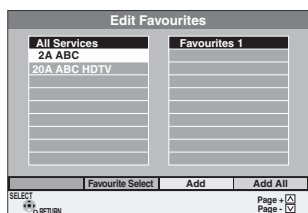

To add channels to a group

- ① Press [▲, ▼] to select the channel in the "All Services" column and press the "Yellow" button.
 - Repeat this step to add other channels.
 - Press the "Blue" button to add all the available channels to the group. (This function is available only when no channels have been added to the group.)
- ② Press [OK] to save the group.

To change the order of channels of a group

- ① Press [▶]*.
- ② Press [▲, ▼] to select the channel in the "Favourite" column to move and press the "Green" button.
- ③ Press [▲, ▼] to select the new position of the channel and press the "Green" button.
 - Repeat the steps ② – ③ to move other channels.
- ④ Press [OK] to save the group.

To delete channels on a group

- ① Press [▶]*.
- ② Press [▲, ▼] to select the channel in the "Favourite" column and press the "Yellow" button.
 - Repeat this step to delete other channels.
 - Press the "Blue" button to delete all the channels from the group.
- ③ Press [OK] to save the group.
Deleting a channel from a group does not affect the channel itself. You can still select the channel from the "All Services" group.

To change the name of a group in the "Favourite" column

- ① Press [▶]*.
- ② Press the "Red" button.
(⇒ 44, Entering text)

* When the station name of the "All Services" column is highlighted

■ Auto-Setup Restart Download from TV

You can restart auto channel setting if set up (⇒ 9) fails for some reason.

However, if you perform "Auto-Setup Restart", the order of analogue channels will change.

Select "Download from TV" when you connect the unit to a VIERA Link (HDAVI Control 3) compatible TV with an HDMI cable.

When the confirmation screen appears

Press [◀, ▶] to select "Yes" and press [OK].

You can also use the following method to restart Auto-Setup.

When the unit is on and stopped

Press and hold [v CH] and [CH ^] on the main unit until the Auto-Setup screen appears.

All the settings except for the ratings level, ratings password and clock settings return to the factory preset. The timer recording programmes are also cancelled.

■ Settings for Digital Services

Press [OK] to show the following settings.

DVB Manual Tuning

You can set channels manually that the DVB Auto-Setup could not complete successfully.

- ① Press [▲, ▼] to select "DVB Manual Tuning" and press [OK].

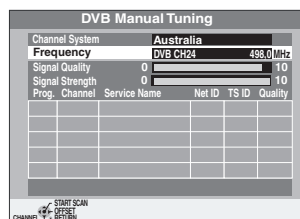

- ② Press [▲, ▼] to select the channel you want to set.
- ③ Press [◀, ▶] to adjust the frequency.
 - The frequency rises and falls in steps of 0.5 MHz.
 - Adjust the frequency by checking the signal strength and signal quality displays.
[Refer to "Signal Condition" (⇒ 60) for signal quality and signal strength.]
- ④ Press [OK] to start scan.
The set channel is displayed in the table.
- ⑤ Press [EXIT] and press [^ v CH] to check that applicable channels have been selected.

Add New DVB Services

You can search for newly added terrestrial digital channels to receive.

- ① Press [▲, ▼] to select "Add New DVB Services" and press [OK].
The unit starts searching for newly available terrestrial digital channels. This takes about 5 minutes.

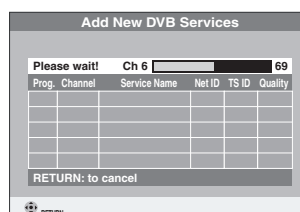

A message is displayed when the search is finished.

"No new services found." is displayed when no new services can be found.

- ② Press [OK] to save the newly found channels.

Signal Condition

You can check the quality and strength of digital broadcast signals. Realign the aerial if you are receiving a poor signal.

When "Signal Condition" is displayed in grey and cannot be selected:

- 1 Press [EXIT] to exit the screen.
- 2 Press [^ v CH] to select a digital channel. "D" appears on the unit's display.
- 3 Display the Setup menu again (⇒ 59).

Press [▲, ▼] to select "Signal Condition" and press [OK]. The quality and strength of the signal are shown.

Press [^ v CH] to select the channel.

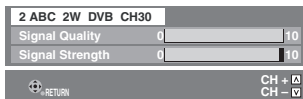

Signal Quality

- Below 2 (display red): The signal quality is so poor that there may be interference in the pictures and sound.
- 2–5 (display orange): The signal quality is basically adequate, but brief interference in the pictures and sound is possible in isolated case.
- Over 5 (display green): Optimum picture and sound quality.

Signal Strength

The display for signal strength is grey. "0" means signal strength 0%, "10" means signal strength 100%. If the signal is too strong, the display will change from grey to red. Reduce the signal amplification at your aerial.

- When the signal is weak:
 - adjust the position and direction of the aerial.
 - adjust the aerial reception with "DVB Manual Tuning" in the Setup menu (⇒ 59).
 - check that the current digital broadcast channel is correctly broadcasting.

Settings for Analogue Services

Press [OK] to show the following setting.

Manual Tuning

You can delete analogue channels and set the analogue channel details.

Press [OK] to show Manual Tuning screen.

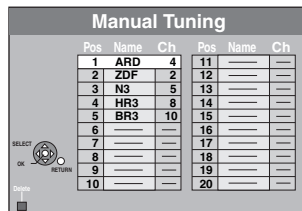

To delete a programme position

Press [▲, ▼, ◀, ▶] to select a programme position and press the "Red" button.

To change the tuning settings for individual programme position

- ① Press [▲, ▼, ◀, ▶] to select a programme position and press [OK].

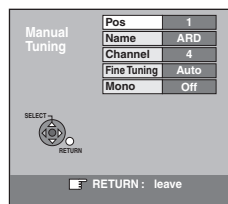

- ② Press [▲, ▼] to select an item and press [▶].

Pos	Programme position in the table (You cannot change the programme position.)
Name	To enter or change the name of a TV station Press [▲, ▼, ◀, ▶] to enter station name and press [OK]. If the station name needs a blank space, select the blank between "Z" and "✽".
Channel	To enter newly available TV stations or change the channel number of an already tuned TV station Press [▲, ▼] or the numbered buttons to enter the channel number of the desired TV station. Wait a few moments until the desired TV station has been tuned. After the desired TV station is tuned, press [OK].
Fine Tuning	To obtain the best tuning condition Press [▲, ▼] to adjust the best tuning condition and press [OK]. •Press [▶] to return to "Auto".
Mono	To select the type of sound to be recorded Press [▲, ▼] to select "On" if the stereo sound is distorted due to inferior reception conditions, or if you want to record the normal (mono) sound during a stereo, bilingual broadcast, and press [OK].

Disc

(All factory default settings are indicated with underlined text.)

Settings for Playback

- Press [OK] to show the following settings.

Ratings

Set a ratings level to limit DVD-Video play. Follow the on-screen instructions. Enter a 4-digit password with the numbered buttons when the password screen is shown.

Do not forget your password.

Setting ratings (When level 8 is selected)

- [8 No Limit] All DVD-Video can be played.
 - [1 to 7] Prohibits play of DVD-Video with corresponding ratings recorded on them.
 - [0 Lock All] Prohibits play of all DVD-Video.
- Changing settings (When level 0 to 7 is selected)
- [Unlock Recorder] [Change Password]
 - [Change Level] [Temporary Unlock]

Soundtrack

- [English] [German] [French] [Italian]
- [Spanish]
- [Original] The original language of each disc will be selected.
- [Other *****]*

Subtitle

- [Automatic] If the language selected for "Soundtrack" is not available, subtitles of that language will automatically appear if available on that disc.
- [English] [German] [French] [Italian]
- [Spanish]
- [Other *****]*

Menus

- [English] [German] [French] [Italian]
- [Spanish]
- [Other *****]*

* [Other *****]

Enter a code (⇒ 73) with the numbered buttons. When the selected language is not available on the disc, the default language is played. There are discs where you can only switch the language from the menu screen (⇒ 16).

DVD-V

- Choose the language for audio, subtitle and disc menus.
- Some discs start in a certain language despite any changes you make here.

Settings for Recording

- Press [OK] to show the following settings.

Recording time in EP mode

Select the maximum number of hours for recording in EP mode (⇒ 21, Recording modes and approximate recording times).

- [EP (6 Hours)] You can record for 6 hours on an unused 4.7 GB disc.
- [EP (8 Hours)] You can record for 8 hours on an unused 4.7 GB disc.

- The sound quality is better when using "EP (6 Hours)" than when using "EP (8 Hours)".

Aspect for Recording

Sets the aspect ratio when recording or copying.

- [Automatic] The programme will be recorded in the original aspect used when recording started (including when recording started at a commercial, etc.).
- [16:9] [4:3]

- When recording or copying to the HDD or DVD-RAM with "Rec for High Speed Copy" set to "Off", programme will be recorded in the original aspect ratio.
- In the following cases, even when set to "Automatic" or "16:9", recordings will be made or copied in 4:3.
 - [R] [R DL] [RW(V)] When the recording mode is set to "EP" or "FR (recordings 5 hours or longer)" mode.
 - When recording or copying to a +R, +R DL and +RW.

Rec for High Speed Copy

You can copy recorded titles from the HDD to DVD-R, DVD-R DL, DVD-RW (DVD-Video format), +R, +R DL and +RW using high speed mode. However, screen size, etc. is restricted (⇒ below).

We recommend turning the setting "Off" if high speed copy to DVD-R, etc. is not necessary when recording a programme. This setting is effective when recording from a television programme or external equipment (including DV equipment), or when copying from a finalised DVD-Video disc.

- [On] You can high-speed copy to DVD-R, etc. Press [◀, ▶] to select "Yes" and press [OK].
 - The following restrictions are applied to recorded titles.
 - Recordings are made using the aspect ratio set in "Aspect for Recording" (⇒ above).
 - Select the type of audio in advance from "Bilingual Audio Selection" (⇒ 62).
 - You are no longer able to switch the audio when watching a programme on an input channel on the TV connected to this unit.

[Off]

DVD Speed for High Speed Copy

Select the speed of high-speed copying (When using high-speed copy compatible DVD-RAM 5X, DVD-R, +R 8X or +RW 4X discs).

- [Maximum]
- [Normal (Silent)] The noise generated by this unit is less than when "Maximum" is selected, however the time required for copying will double (approximately).

Picture

(All factory default settings are indicated with underlined text.)

Comb Filter

Select the picture sharpness when recording.
The setting is fixed with "On" if you set "TV System" to "NTSC" (➔ 64).

[On] Pictures become clear and vivid. Normally, use this setting.

[Off] Select it when recording noisy pictures.

Still Mode

Select the type of picture shown when you pause play (➔ 84, Frames and fields).

[Automatic]

[Field] Select if jittering occurs when "Automatic" is selected. (The picture is coarser.)

[Frame] Select if small text or fine patterns cannot be seen clearly when "Automatic" is selected. (The picture is clearer and finer.)

Seamless Play

Select the play mode between playlist chapter segments and partially deleted titles.

[On] The chapters in playlists are played seamlessly. This does not work when there are several audio types included on the playlist and when using Quick View (PLAY×1.3). Additionally, the positioning of chapter segments may change slightly.

[Off] The points where chapters in playlists change are played accurately, but the picture may freeze for a moment.

Sound

(All factory default settings are indicated with underlined text.)

Dynamic Range Compression

DVD-V (Dolby Digital only)

Change the dynamic range for late night viewing.

[On] [Off]

Bilingual Audio Selection

(Analogue broadcast only)

Select whether to record the main or secondary audio type when:

- Recording or copying to a DVD-R, DVD-R DL, DVD-RW (DVD-Video format), +R, +R DL and +RW.
- "Rec for High Speed Copy" is set to "On".
- Recording or copying sound in LPCM (➔ right, "Audio Mode for XP Recording").

[M 1] [M 2]

• You cannot select the audio on this unit when recording from an external source, such as when copying from a video cassette recorder (except from DV equipment connected to this unit's DV input terminal). Select the audio on the other equipment.

• When recording from the unit's DV terminal, select the type of audio recording from "Audio Mode for DV Input" (➔ right).

Digital Audio Output

Change the settings when you have connected equipment through this unit's DIGITAL AUDIO OUT terminal (➔ 69).

- Press [OK] to show the following settings.

PCM Down Conversion

Select how to output audio with a sampling frequency of 96 kHz.

- Signals are converted to 48 kHz despite the settings below if the signals have a sampling frequency of over 96 kHz, or the disc has copy protection.

[On] Signals are converted to 48 kHz. (Choose when the connected equipment cannot process signals with a sampling frequency of 96 kHz.)

[Off] Signals are output as 96 kHz. (Choose when the connected equipment can process signals with a sampling frequency of 96 kHz.)

Dolby Digital

Select how to output the signal.



Select "Bitstream" if the connected equipment decodes the signal.

Select "PCM" if this unit decodes the signal and outputs it as 2 channels.

- Not making the proper settings may result in noise.

[Bitstream] When connecting to equipment displaying the Dolby Digital logo.

[PCM] When connecting to equipment not displaying the Dolby Digital logo.

DTS

Select how to output the signal.

Select "Bitstream" if the connected equipment decodes the signal.

Select "PCM" if this unit decodes the signal and outputs it as 2 channels.

- Not making the proper settings may result in noise.



[Bitstream] When connecting to equipment displaying the DTS logo.

[PCM] When connecting to equipment not displaying the DTS logo.

MPEG

Select how to output the signal.

Select "Bitstream" if the connected equipment decodes the signal.

Select "PCM" if this unit decodes the signal and outputs it as 2 channels.

- Not making the proper settings may result in noise.

[Bitstream] When connected to equipment with a built-in MPEG decoder.

[PCM] When connected to equipment without a built-in MPEG decoder.

Audio Mode for XP Recording

Choose the audio type when recording or copying with XP mode.

[Dolby Digital] (➔ 84) [LPCM] (➔ 84)

- The picture quality of LPCM recordings may be lower than that of normal XP mode recordings.
- The audio recording becomes Dolby Digital even if you selected LPCM when using a recording mode other than XP.
- When recording a bilingual broadcast, select the type of audio in advance from "Bilingual Audio Selection" (➔ left).

Audio Mode for DV Input

You can select the kind of audio when recording from the unit's DV input terminal (➔ 23).

[Stereo 1] Records audio (L1, R1).

[Stereo 2] Records added audio such as narration (L2, R2) subsequent to original recording.

[Mix] Records both Stereo 1 and Stereo 2.

- When recording bilingual broadcast, select the type of audio in advance from "Bilingual Audio Selection" (➔ left).

Display

(All factory default settings are indicated with underlined text.)

On-Screen Messages

Choose the approximate time until the digital channel information screen (⇒ 15) disappears automatically. The length of time the control panel (⇒ 37) is displayed can also be changed, but "Off" does not work.

[Off] (The digital channel information is not displayed.)

[3 sec.] [5 sec.] [7 sec.] [10 sec.]

Grey Background

Select "Off" if you do not want to have the unit show the grey background when tuner reception is weak.

[On] [Off]

FL Display

Changes the brightness of the unit's display. This setting is fixed with "Automatic" if you set "Power Save" (⇒ 65) to "On".

[Bright] [Dim]

[Automatic] The display turns dark during play and disappears when the unit is turned off. It reappears momentarily if a button is pressed. While using this mode, the standby power consumption can be reduced.

New Service Message (⇒ 15)

When a new DVB channel is added this unit will be informed automatically. Then the confirmation message appears. If you select "Yes" on the display, Auto-Setup starts (all channel settings and all created groups are deleted. The timer recording programmes are also cancelled.)

[Automatic]

[Off] The service messages are not shown.

Pause Live TV Icon

Select "Off" if you do not want to have the unit show the on-screen icon while using the Pause Live TV function.

[On] [Off]

Connection

(All factory default settings are indicated with underlined text.) Depending on the connected equipment, some items may be shaded in grey on the display and cannot be selected, or you may not be able to change the settings.

TV Aspect

Set to match the type of television connected.

[16:9] When connected to a 16:9 widescreen television.

[Pan & Scan] When connected to a 4:3 aspect television, side picture is trimmed for 16:9 picture.



[Letterbox] When connected to a 4:3 aspect television. 16:9 picture is shown in the letterbox style.



Progressive

You can enjoy progressive video by connecting this unit's COMPONENT VIDEO OUT terminals to an LCD/plasma television or LCD projector compatible with progressive scan. This setting is fixed with "Off" if you set "AV1 Output" to "RGB 1 (without component)" or "RGB 2 (without component)".

[On] [Off]

Note

- When connected to a regular television (CRT: Cathode ray tube) or a multi system television using PAL mode, even if it is progressive compatible, progressive output can cause some flickering. Turn off "Progressive" if you are concerned about it (➔ 54).
- Picture will not be displayed correctly if connected to an incompatible television.

TV System

Change the setting to match the equipment you are connecting with, or to match the title when there are both PAL and NTSC titles on the HDD.

[PAL]

- Select when connecting to a PAL or Multi-system television. Titles recorded using NTSC are played as PAL 60.
- Select to record television programmes and PAL input from other equipment.
- [HDD] Select when playing a PAL input title recorded on the HDD.

[NTSC]

- Select when connecting to a NTSC television. Television programmes cannot be recorded properly.
- Select to record NTSC input from other equipment.
- [HDD] Select when playing a NTSC input title recorded on the HDD.

Note

- This unit cannot record NTSC signals to discs that already have PAL signal recordings. (However, both types of programmes can be recorded onto the HDD.)
- If "NTSC" has been selected, the TV Guide system cannot be used.
- A disc or title with different "TV System" may not be able to playback while recording or on standby for the timer recording. You will be able to playback by changing the "TV System" settings in that case, but to prevent failure of the timer recording, change back the settings before the recording starts.

To change the setting all at once (PAL↔NTSC)

While stopped, keep pressing [■] and [▲ OPEN/CLOSE] on the main unit at the same time for 5 or more seconds.

HDMI Settings

- Press [OK] to show the following settings.

HDMI Video Format

You can only select items compatible with the connected equipment. This setting normally does not need to be changed. However if you are concerned about output picture quality, it may be improved by changing the setting.

- To enjoy High Quality Video up-converted to 1080p, you need to connect the unit directly to 1080p compatible HDTV. If this unit is connected to an HDTV through other equipment, it must also be 1080p compatible.

[576i/480i] [576p/480p] [720p] [1080i]

[1080p] When outputting 1080p signal, we recommend using High Speed HDMI Cables that have the HDMI logo (as shown on the cover) and are less than 5.0 meters to prevent video distortion etc.

[Automatic] Automatically selects the output resolution best suited to the connected television (1080p, 1080i, 720p, 576p/480p or 576i/480i).

Aspect for 4:3 Video

To play a 4:3 title when connected with an HDMI cable, set how to show pictures on a 16:9 widescreen television.

[4:3] Picture output expands left or right.



[16:9] Picture is output as original aspect with side panels.



Digital Audio Output

[HDMI and Optical]

[Optical Only]

Select when this unit is connected to an amplifier with an optical digital audio cable and connected to a TV with an HDMI cable and you want to enjoy the highest quality of audio from discs (➔ 69).

VIERA Link

Set to use "HDAVI Control" function when connected with an HDMI cable to a device that supports "HDAVI Control".

[On]

[Off] Select when you do not want to use "HDAVI Control".

AV1 Output

Set according to the terminal of the connected TV. Select "Video (with component)" or "S Video (with component)" for component output (progressive output).

If this unit is connected with an HDMI cable, you cannot select "RGB 1 (without component)" or "RGB 2 (without component)".

[Video (with component)]

Select when a TV is connected that can receive a composite signal.

[S Video (with component)]

Select when a TV is connected that can receive an S Video signal.

[RGB 1 (without component)]

Select when a TV is connected that can receive an RGB signal. If you always would like to view the picture from the unit in RGB signal, select this mode. The TV screen will automatically switch to display the picture from the unit when the unit is turned on.

[RGB 2 (without component)]

Select when a TV is connected that can receive an RGB signal. If you would like to switch to display the picture from the unit only when playback or viewing menus, select this mode.

AV2 Input

Set according to the output signal of the connected equipment.

[Video]

[S Video]

Others

(All factory default settings are indicated with underlined text.)

Remote Control

Change the remote control code on the main unit and the remote control (the two must match) if you place other Panasonic products close together.

[DVD 1] [DVD 2] [DVD 3]

Use "DVD 1", the factory set code, under normal circumstances.

- Press [**▲**, **▼**] to select the code ("DVD 1", "DVD 2" or "DVD 3") and press [OK].

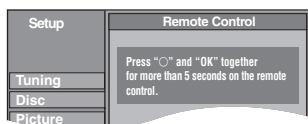

To change the code on the remote control

- While pressing [OK], press and hold the numbered button ([1], [2] or [3]) for more than 5 seconds.
- Press [OK].

■ When the following indicator appears on the unit's display



The unit's remote control code

Change the code on the remote control to match the main unit's (⇒ step 2).

Note

Executing "Shipping Condition" in the Setup menu returns the main unit code to "DVD 1". Change the remote control code to 1 (⇒ step 2).

Clock

This unit usually obtains time and date information from digital broadcasts and automatically corrects the time several times a day. However, if the time is not set correctly use the settings listed in the method below.

- In the case of a power failure, the clock setting remains in memory for approximately 60 minutes.

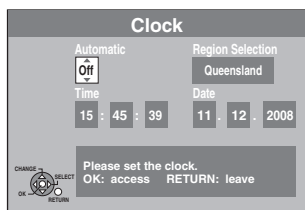

e.g.,
This screen appears while receiving a digital broadcast.

- Press [**▲**, **▼**] to select "Off" of "Automatic" and press [OK].
- Press [**◀**, **▶**] to select the item you want to change.
The items change as follows:
Hour ↔ Minute ↔ Second ↔ Day ↔ Month ↔ Year

Reset the clock regularly to maintain accuracy.
(Monthly accuracy +/- 15 seconds.)

- Press [**▲**, **▼**] to change the setting.
You can also use the numbered buttons for setting.
- Press [OK] when you have finished the settings.
The clock starts.

Note

If a TV station transmits a time setting signal, and when "Automatic" in the Clock setting menu is set to "On", the automatic time correction function checks the time and if necessary it is adjusted several times every day.

■ To change the region

- Press [**▲**, **▼**] to set "Automatic" to "On" and press [OK] in step ①.
- Press [**▲**, **▼**] to select the correct region and press [OK].
Auto clock setting starts. This takes a few minutes.
"Automatic clock setting completed." screen is displayed.
- Press [RETURN] to exit the screen.

Power Save

[On] Power consumption is minimized when the unit is turned to standby (⇒ 83).

[Off]

(If "Quick Start" is set to "On", "Power Save" is automatically turned to "Off".)

- Refer to the following when "Power Save" is set to "On".
 - "FL Display" is automatically set to "Automatic" (⇒ 63).
 - The "Quick Start" function does not work. (It is automatically turned to "Off".)

Quick Start

1 Sec. Quick Start for Recording & EPG Display

(When connecting to TV using 21-pin Scart, COMPONENT VIDEO, VIDEO or S VIDEO terminals)

From the power on, recording on DVD-RAM and HDD starts in about 1 second after the REC button is pressed. If the GUIDE button is pressed while the unit is off, the Electronic Program Guide (EPG) displays in less than 1 second. (Quick Start Mode)

[On]

[Off] Standby power consumption is less than when this is set to "On".

(If this is set to "On", "Power Save" is automatically turned to "Off".)

- Startup takes up to a minute when:
 - You play a disc or start recording to discs other than DVD-RAM.
 - You want to make other operations.
 - The clock has not been set.
- Depending on the type of TV or the connected terminal, it may take time to display the screen.

DivX Registration

You need this registration code to purchase and play DivX Video-on-Demand (VOD) content (⇒ 31).

System Update

In order to update this unit's software, the TV Guide download, and to support system changes made by broadcasts, this unit periodically performs software updates.

Press [OK] to show the following settings.

- Update data and TV Guide download information is sent by an unscheduled digital broadcast. In order to receive these updates, you must be able to receive digital broadcasts.
- An update will take approximately 60 minutes. While the update is in progress, "SW-DL" appears on the unit's display. You cannot operate the unit until the update is complete. Removing the AC mains lead while the update is in progress may damage the unit.
- TV Guide download will take approximately 60 minutes. While the TV Guide download is in progress, "GUIDE" appears on the unit's display. The TV Guide download can be interrupted by switching on the unit.

TV Guide Download in Standby

[On] When you set this unit to standby mode, TV Guide data is downloaded automatically.

[Off]

Software Update in Standby

[On] When you set this unit to standby mode, software updates are downloaded automatically.

[Off]

TV Guide/Software search period

Selects the time to automatically perform TV Guide download and updates when the unit is set to standby mode. This can only be set when "TV Guide Download in Standby" and "Software Update in Standby" is set to "On".

- If there is a programmed recording set for the time you have selected, the programmed recording will be given priority.

[Automatic] The unit will give priority to searching for TV Guide download and update data at midnight.

[02:00–06:00] [06:00–10:00] [10:00–14:00]

[14:00–18:00] [18:00–22:00] [22:00–02:00]

Software Update Search Now

Start the search for new software manually.

A new software version is announced by a message. Do not turn your unit off during the update. This could result in the loss of data. A message shows that the update has finished.

If a new software version is not going to be broadcast for the next few days, a corresponding message also appears.

- If applicable update data is found, press [◀, ▶] to select "Yes" and press [OK].

Initialize

- Press [OK] to show the following settings.

Shipping Condition

All the settings except for the ratings level, ratings password and clock settings return to the factory preset. The timer recording programmes are also cancelled.

[Yes] [No]

Default Settings

All the settings other than the tuning settings, clock settings, region settings, disc language settings, ratings level, ratings password, remote control code, return to the factory presets.

[Yes] [No]

List of TV Reception Channels

Tuner System	Channel Coverage	VHF	UHF	CATV
PAL-B	Australia Analogue	0–12	28–69	45 MHz to 470 MHz
DVB-T	Australia Digital	6–12	27–69	–

Television operation

You can configure the remote control TV operation buttons to turn the television on/off, change the television input mode, select the television channel and change the television volume.

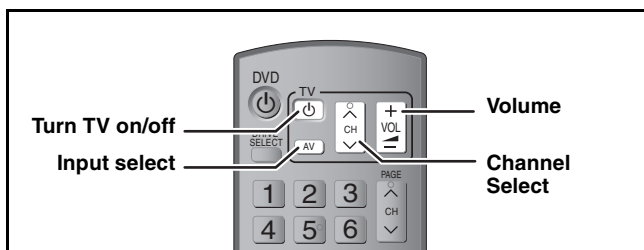

1 Point the remote control at the television

While pressing [TV], enter the code with the numbered buttons.

e.g., 01: [0] → [1] 10: [1] → [0]

Manufacturer and Code No.

Brand	Code	Brand	Code
Panasonic	01/02/03/04	METZ	05/28
AIWA	35	MITSUBISHI	05/19/20/47
AKAI	27/30	MIVAR	24
BEJING	33	NEC	36
BEKO	05/71/72/73/74	NOBLEX	33
BENQ	58/59	NOKIA	25/26/27/60/61
BP	09	NORDMENDE	10
BRANDT	10/15	OLEVIA	45
BUSH	05	ONWA	30/39/70
CENTREX	66	ORION	05
CHANGHONG	69	PEONY	49/69
CURTIS	05	PHILCO	41/48/64
DAEWOO	64/65	PHILIPS	05/06/46
DESMET	05	PHONOLA	05
DUAL	05	PIONEER	37/38
ELEMIS	05	PROVIEW	52
FERGUSON	10/34	PYE	05
FINLUX	61	RADIOLA	05
FISHER	21	SABA	10
FUJITSU	53	SALORA	26
FUNAI	63/67	SAMSUNG	32/42/43/65/68
GOLDSTAR	05/50/51	SANSUI	05
GOODMANS	05	SANYO	21/54/55/56
GRADIENTE	36	SCHNEIDER	05/29/30
GRUNDIG	09	SEG	05/69/75/76/77/78
HIKONA	52	SELECO	05/25
HITACHI	05/22/23/40/41	SHARP	18
INNO HIT	05	SIEMENS	09
IRRADIO	30	SINUDYNE	05
ITT	25	SONY	08
JINGXING	49	TCL	31/33/66/67/69
JVC	17/30/39/70	TELEFUNKEN	10/11/12/13/14
KDS	52	TEVION	52
KOLIN	45	TEX ONDA	52
KONKA	62	THOMSON	10/15/44
LG	05/50/51	TOSHIBA	16/57
LOEWE	07/46	WHITE WESTINGHOUSE	05
MAG	52	YAMAHA	18/41

2 Test by turning on the television and changing channels.

- Repeat the procedure until you find the code that allows correct operation.
- If your television brand is not listed or if the code listed for your television does not allow control of your television, this remote control is not compatible with your television.

Note

- If your television brand has more than one code listed, select the one that allows correct operation.

Child Lock

The Child Lock deactivates all buttons on the unit and remote control. Use it to prevent other people from operating the unit.

Press and hold [OK] and [RETURN] simultaneously until “X HOLD” appears on the unit’s display.



If you press a button while the Child Lock is on, “X HOLD” appears on the unit’s display and operation is impossible.

To cancel the Child Lock

Press and hold [OK] and [RETURN] simultaneously until “X HOLD” disappears.

Additional connections

* Leave "Yellow" unconnected.

Connecting a television with S VIDEO terminals

The S VIDEO OUT terminal achieves a more vivid picture than the VIDEO OUT terminal. (Actual results depend on the television.)

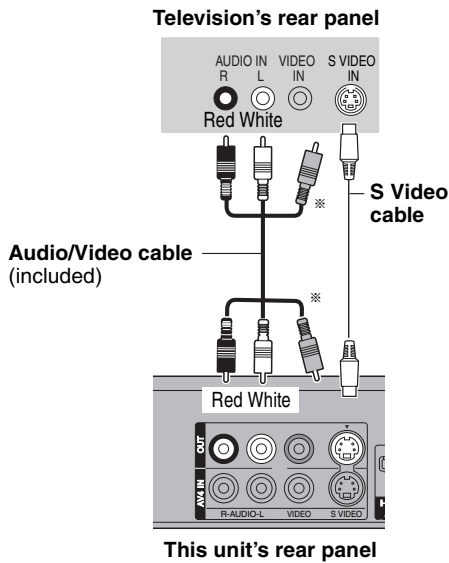

Connecting a television with COMPONENT VIDEO terminals

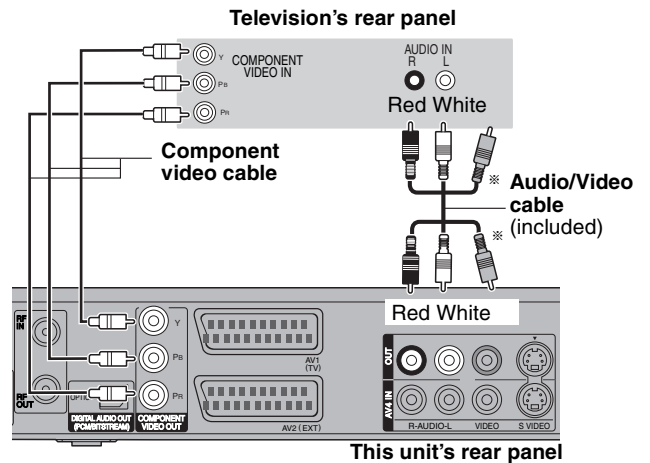

COMPONENT VIDEO terminals can be used for either interlace or progressive output (⇒ 84) and provide a purer picture than the S VIDEO OUT terminal.

- Connect to terminals of the same colour.

Required setting

"Progressive" setting in the Setup menu (⇒ 64)

If you have a regular television (CRT: cathode ray tube)

Progressive output may cause some flickering, even if it is progressive compatible. Turn off "Progressive" if you are concerned about it (⇒ 54). This is the same for multi system televisions using PAL mode.

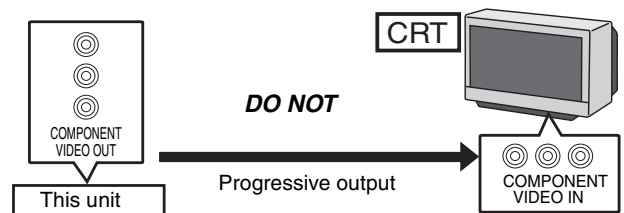

Connecting an amplifier with a digital input terminal

- To enjoy multi-channel surround sound DVD-Video, connect an amplifier with Dolby Digital, DTS and MPEG decoders.

Required setting

“Digital Audio Output” in the Setup menu (⇒ 62)

- When this unit is connected to an amplifier with an optical digital audio cable and connected to a television with an HDMI cable, you can enjoy the highest quality of audio from the disc by setting “Digital Audio Output” to “Optical Only” in the Setup menu (⇒ 64). In this case audio is only output from the amplifier not the television.
- Before purchasing an optical digital audio cable (not included), check the terminal shape of the connected equipment.
- You cannot use DTS Digital Surround decoders not suited to DVD.

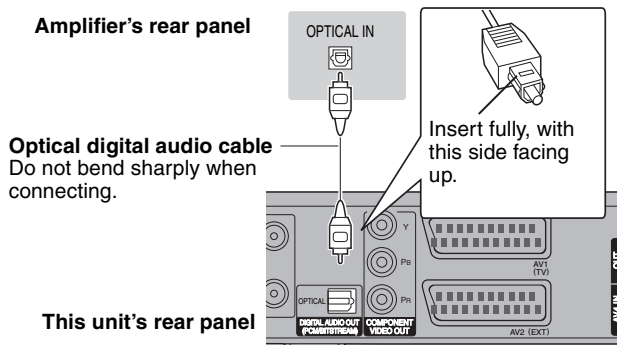

Connecting a stereo amplifier

Amplifier's rear panel

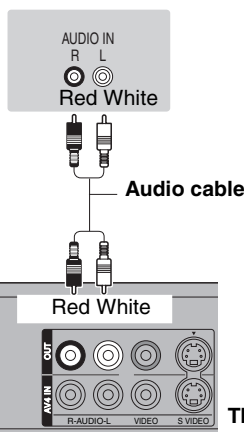

Connecting with an HDMI compatible television and receiver

When connected to an HDMI compatible unit, an uncompressed digital audio and video signal is transmitted. You can enjoy high quality, digital video and audio with just one cord. When connecting to an HDMI-compatible HDTV (High Definition Television), the output can be switched to 1080p, 1080i or 720p HD video.

- Video sources converted to 1920×1080 resolution, while of high quality, will exhibit somewhat lower subjective image resolution than true, native 1080p full-HD sources. See dealer for details.
- Please use High Speed HDMI Cables that have the HDMI logo (as shown on the cover).
- When outputting 1080p signal, please use HDMI Cables 5.0 meters or less.

Regarding VIERA Link “HDAVI Control™” function

When connecting with a Panasonic TV (VIERA) or a receiver equipped with the “HDAVI Control” function, linked operations would be possible. [⇒ 36, Linked operations with the TV (VIERA Link “HDAVI Control™”)]

- Non-HDMI-compliant cables cannot be utilised.
- It is recommended that you use Panasonic's HDMI cable.

Recommended part number:

RP-CDHG10 (1.0 m), RP-CDHG15 (1.5 m), RP-CDHG20 (2.0 m), RP-CDHG30 (3.0 m), RP-CDHG50 (5.0 m), etc.

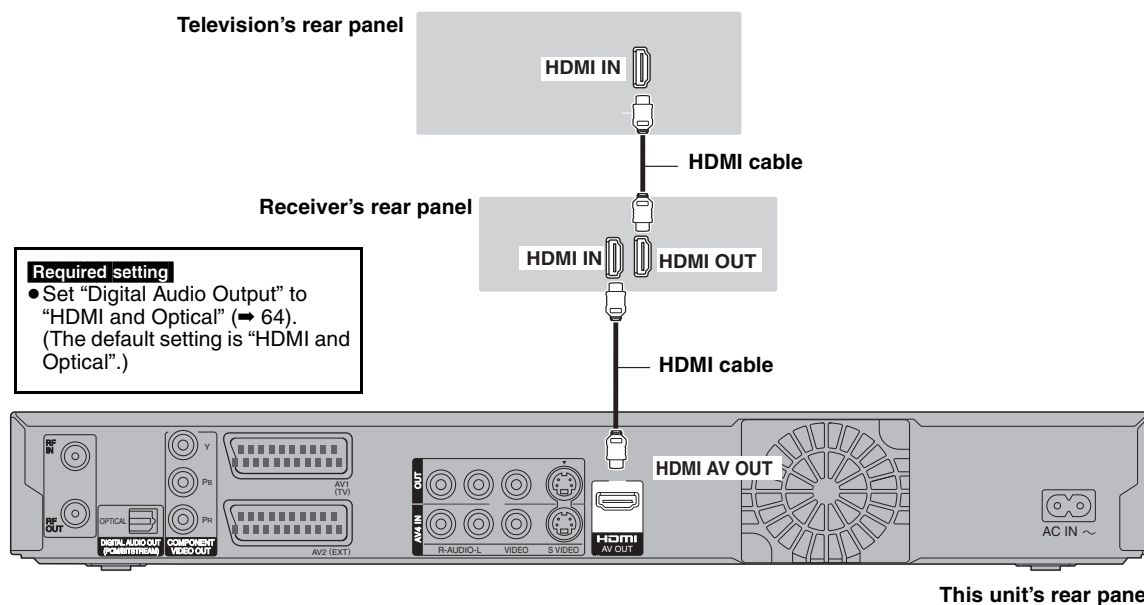

Note

- If you are connecting to a TV that is only compatible with 2 channel audio output, audio with 3 channels or more will be down mixed (⇒ 84) and output as 2 channels, even if connecting with an HDMI cable. (Some discs cannot be down mixed.)
- You cannot connect this unit to DVI devices that are incompatible with HDCP. For units compatible with HDCP (High-Bandwidth Digital Content Protection) copyright protection that are equipped with a digital DVI input terminal (PC monitors, etc.): Depending on the unit, images may not display properly or at all when connecting with a DVI/HDMI switching cable. (Audio cannot be output.)

Connecting a television and VCR

Connecting to a television with 21-pin Scart terminal

You can also connect with the AV1 terminal on this unit using the 21-pin Scart cable.

If your television is equipped with RGB input capability, by connecting with a fully wired 21-pin Scart cable you can see video using RGB output on this unit.

Required setting

"AV1 Output" in the Setup menu (⇒ 64)

Connecting to a VCR with 21-pin Scart terminal

You can also connect with the AV2 terminal on this unit using the 21-pin Scart cable.

Required setting

"AV2 Input" in the Setup menu (⇒ 64)

Connect the unit directly to the television

If you connect the unit through an AV selector or video cassette recorder to the television, video signal will be affected by copyright protection systems and the picture may not be shown correctly.

•When connecting to a television with a built-in VCR

Connect to the input terminals on the television side if there are both television and VCR input terminals.

DO NOT

Television



VCR



This unit

Connecting an Analogue television and VCR

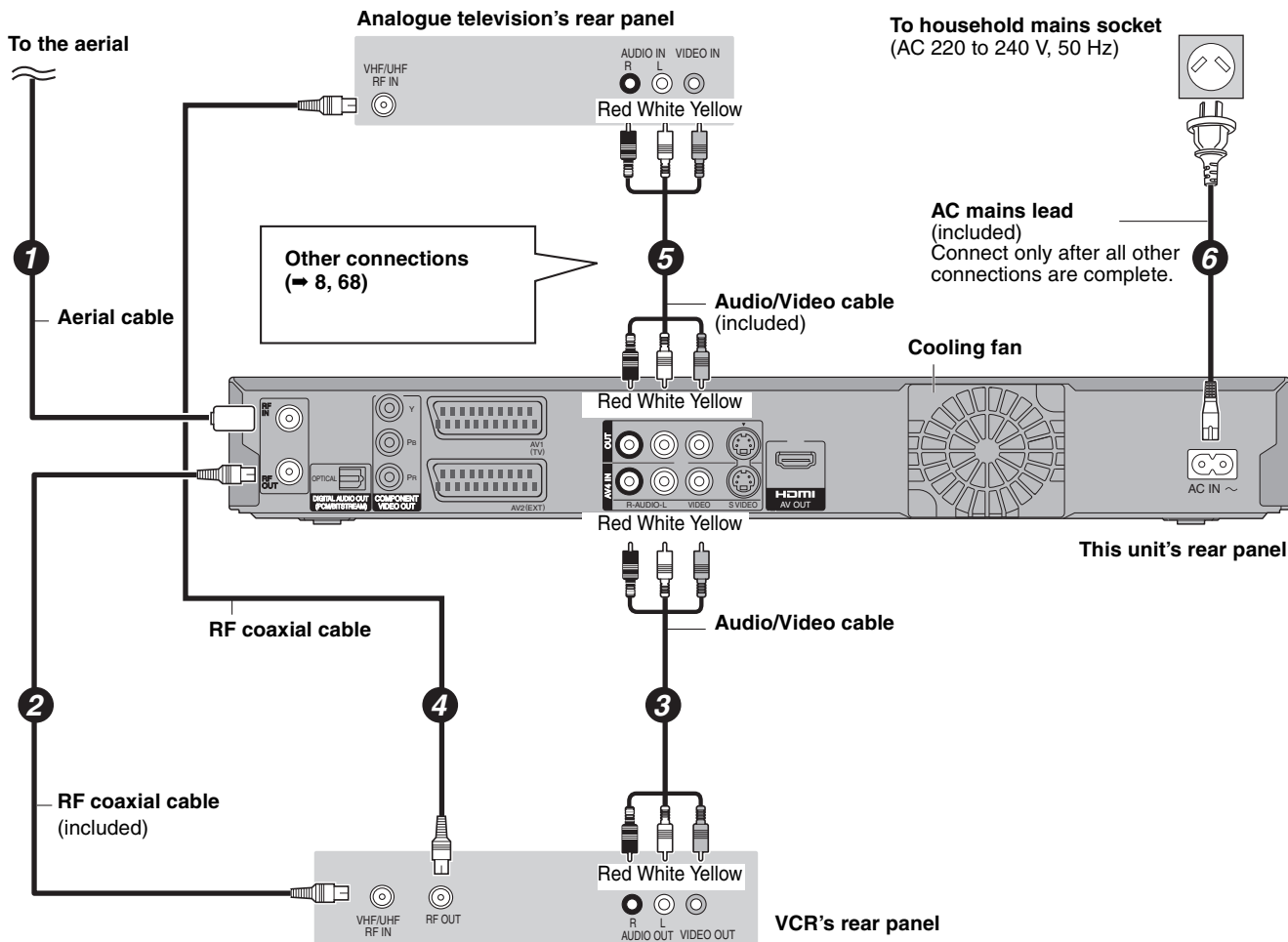

Connecting a Digital television and VCR

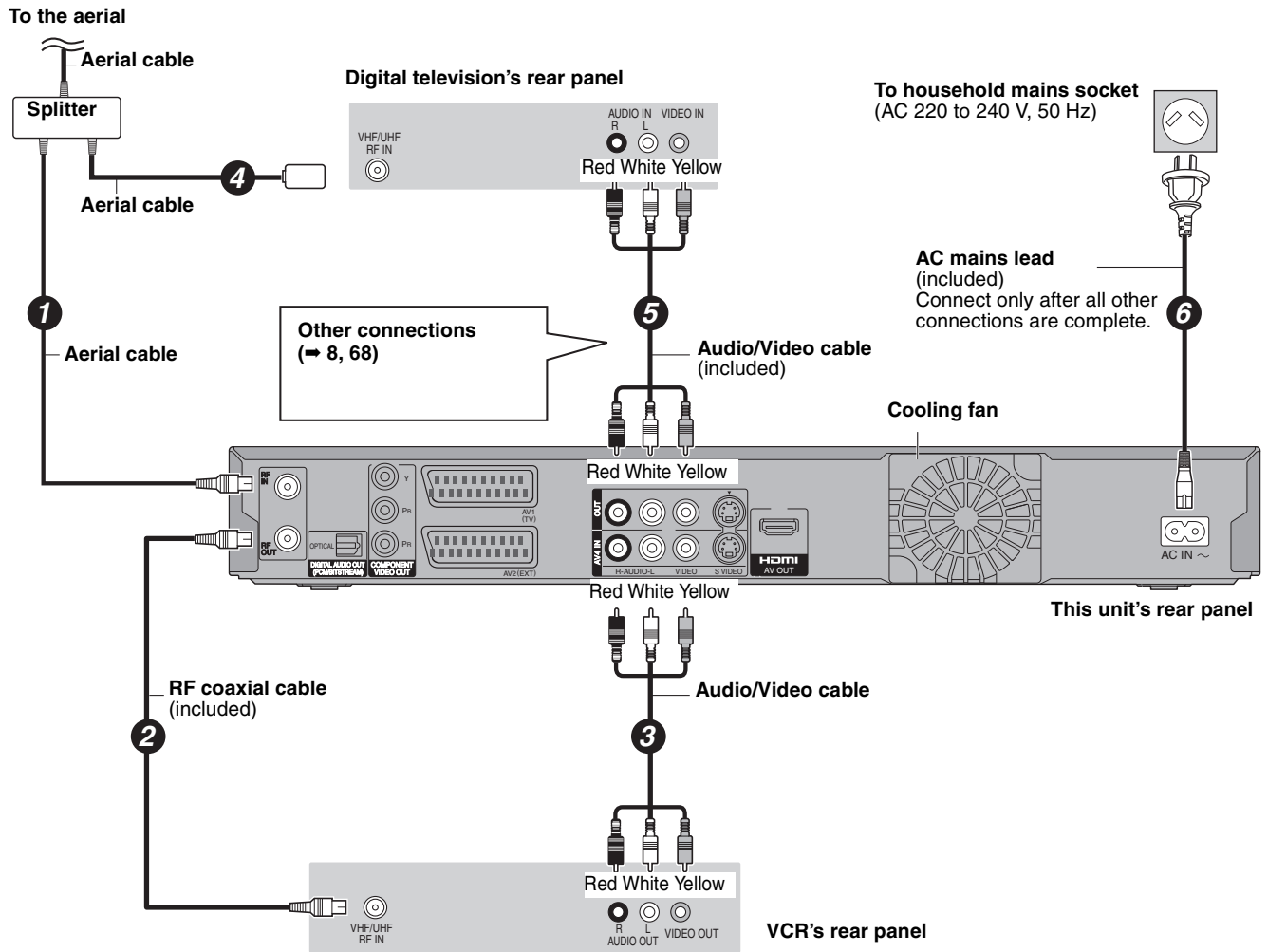

Additional connections

Frequently asked questions

Refer to the following items if you have any doubts about unit operations.

Set up		Page
Which aerial is suitable for receiving digital terrestrial broadcasts?	<ul style="list-style-type: none"> You can use your current aerial. However, depending on the area where you live, a new aerial may be necessary. Consult your local TV aerial installer. 	—
Can this unit receive or record High Definition (HD) broadcasts?	<ul style="list-style-type: none"> No, this unit cannot receive or record High Definition (HD) broadcasts. 	—
What equipment is necessary to play multi channel surround sound?	<ul style="list-style-type: none"> You cannot playback multi-channel sound on this unit without other equipment. You must connect this unit with an HDMI cable or an optical digital cable to an amplifier with a built-in (Dolby Digital, DTS or MPEG) decoder. 	69
Are the headphones and speakers directly connected to the unit?	<ul style="list-style-type: none"> You cannot directly connect them to the unit. Connect through the amplifier etc. 	69
The television has both S VIDEO IN terminal and COMPONENT VIDEO IN terminals. Which terminal should I connect with?	<ul style="list-style-type: none"> Connecting with the component video out terminal provides a more vivid picture compared to connecting with the S Video out terminal. If you have an LCD/plasma television or LCD projector compatible with progressive scan, connect through the component video terminals for high-quality progressive video. If you have a CRT television or a multi system television using PAL mode that is compatible with progressive scan, we cannot recommend progressive output as some flickering can occur. 	68
Is my television progressive output compatible?	<ul style="list-style-type: none"> All Panasonic televisions that have 576 (625)/50i · 50p, 480 (525)/60i · 60p input terminals are compatible. Consult the manufacturer if you have another brand of television. 	—
Disc		
Can I play DVD-Video and Video CDs bought in another country?	<ul style="list-style-type: none"> You cannot play DVD-Video if their region number does not include “4” or “ALL”. Refer to the disc’s jacket for more information. 	Cover
Can a DVD-Video that does not have a region number be played?	<ul style="list-style-type: none"> The DVD-Video region number indicates the disc conforms to a standard. You cannot play discs that do not have a region number. You also cannot play discs that do not conform to a standard. 	—
Please tell me about disc compatibility with this unit.	<ul style="list-style-type: none"> This unit records and plays DVD-R, DVD-RW (DVD-Video format), +R, and +RW, and plays DVD-RW (DVD Video Recording format). However you cannot directly record to a DVD-R DL or +R DL disc on this unit (playback and copy are possible). This unit also records and plays high speed recording compatible DVD-R, DVD-R DL, DVD-RW, +R, +R DL, +RW discs. 	10–11
	<ul style="list-style-type: none"> This unit plays CD-R/CD-RW discs which have been recorded in one of the following standards: CD-DA, Video CD, DivX, MP3 and still pictures (JPEG). You cannot write to a CD-R or CD-RW with this unit. 	11, 13
		—
Recording		
Can I record from a commercially purchased video cassette or DVD?	<ul style="list-style-type: none"> Most commercially sold video cassettes and DVD are copy protected; therefore, recording is usually not possible. 	—
Can DVD-R, DVD-R DL, DVD-RW (DVD-Video format), +R, +R DL and +RW recorded on this unit be played on other equipment?	<ul style="list-style-type: none"> You can play on compatible equipment such as DVD players after finalising the disc on this unit. However, depending on the condition of the recording, the quality of the disc and capabilities of the DVD player, play may not be possible. If you play a DVD-R DL, +R DL or +RW, use compatible equipment. 	—
	<ul style="list-style-type: none"> You can record if using the PCM signal. When recording DVD, change the “Digital Audio Output” settings to the following in the Setup menu. <ul style="list-style-type: none"> – PCM Down Conversion: On – Dolby Digital/DTS/MPEG: PCM However, only as long as digital recording from the disc is permitted and the recording equipment is compatible with a sampling frequency of 48 kHz. You cannot record MP3 signals. 	62
(Analogue broadcast only) Can I switch to bilingual broadcast during recording?	<ul style="list-style-type: none"> With HDD and DVD-RAM, you can. Just press [AUDIO]. (When “Rec for High Speed Copy” is set to “Off”) With DVD-R, DVD-RW (DVD-Video format), +R, +RW you cannot. Change before recording with “Bilingual Audio Selection” in the Setup menu. 	28
	<ul style="list-style-type: none"> With DVD-R, DVD-RW (DVD-Video format), +R, +RW you cannot. Change before recording with “Bilingual Audio Selection” in the Setup menu. 	62
Can I high speed copy to a disc?	<ul style="list-style-type: none"> Yes, you can. (When “Rec for High Speed Copy” was set to “On” before recording the programme.) Depending on the disc type, the maximum speed varies. 	45

TV Guide		Page
Is it possible to programme a recording, with a start and end time that are different from the TV Guide system?	<ul style="list-style-type: none"> You can manually change the start and end time of programmes in the Timer Recording menu. 	24
Can I receive TV Guide system data via a connected satellite receiver or a Set Top Box?	<ul style="list-style-type: none"> No, only via the built-in tuner. To perform timer recordings with satellite receivers or Set Top Boxes, please use your unit's manual timer programming. 	24
How can I cancel a TIMER programming?	<ul style="list-style-type: none"> Press [PROG/CHECK] and select the desired entry and then press [DELETE *]. 	25
What happens when I unplug the unit from the household mains socket?	<ul style="list-style-type: none"> The TV Guide data will not be updated. If the unit is disconnected from the household mains socket for a longer period of time, the TV Guide data will be lost. Clock setting will be erased and timer recording will not work. 	—
USB		
What can or cannot be done using the USB port on this unit?	<ul style="list-style-type: none"> You can play DivX, MP3 or still picture (JPEG) files on a USB memory. 	30
	<ul style="list-style-type: none"> You can copy still pictures (JPEG) files on a USB memory to the HDD or DVD-RAM. 	50
	<ul style="list-style-type: none"> You can copy MP3 files on a USB memory to the HDD. 	52
	<ul style="list-style-type: none"> EX88 You can connect a video equipment and copy SD Video to the HDD or DVD-RAM 	49
	<ul style="list-style-type: none"> Data on the HDD or a disc cannot be transferred to a USB memory. Data on a USB memory cannot be edited or a USB memory cannot be formatted on this unit. Some USB memories cannot be used with this unit. 	12
Music		
What will happen if I try to record the same CD multiple times?	<ul style="list-style-type: none"> New album will be made following the existing album. 	—
Can I transfer the music tracks from HDD to the disc or USB memory?	<ul style="list-style-type: none"> No, you cannot. 	—

Language code list

Enter the code with the numbered buttons.

Abkhazian: 6566	Catalan: 6765	Gujarati: 7185	Lingala: 7678	Rhaeto-Romance: 8277	Tamil: 8465
Afar: 6565	Chinese: 9072	Hausa: 7265	Lithuanian: 7684	Romanian: 8279	Tatar: 8484
Afrikaans: 6570	Corsican: 6779	Hebrew: 7387	Macedonian: 7775	Russian: 8285	Telugu: 8469
Albanian: 8381	Croatian: 7282	Hindi: 7273	Malagasy: 7771	Samoan: 8377	Thai: 8472
Amharic: 6577	Czech: 6783	Hungarian: 7285	Malay: 7783	Sanskrit: 8365	Tibetan: 6679
Arabic: 6582	Danish: 6865	Icelandic: 7383	Malayalam: 7776	Scots Gaelic: 7168	Tigrinya: 8473
Armenian: 7289	Dutch: 7876	Indonesian: 7378	Maltese: 7784	Serbian: 8382	Tonga: 8479
Assamese: 6583	English: 6978	Interlingua: 7365	Maori: 7773	Serbo-Croatian: 8372	Turkish: 8482
Aymara: 6589	Esperanto: 6979	Irish: 7165	Marathi: 7782	Shona: 8378	Turkmen: 8475
Azerbaijani: 6590	Estonian: 6984	Italian: 7384	Moldavian: 7779	Sindhi: 8368	Twi: 8487
Bashkir: 6665	Faroese: 7079	Japanese: 7465	Mongolian: 7778	Singhalese: 8373	Ukrainian: 8575
Basque: 6985	Fiji: 7074	Javanese: 7487	Nauru: 7865	Slovak: 8375	Urdu: 8582
Bengali; Bangla: 6678	Finnish: 7073	Kannada: 7578	Nepali: 7869	Slovenian: 8376	Uzbek: 8590
Bhutani: 6890	French: 7082	Kashmiri: 7583	Norwegian: 7879	Somali: 8379	Vietnamese: 8673
Bihari: 6672	Frisian: 7089	Kazakh: 7575	Oriya: 7982	Spanish: 6983	Welsh: 6789
Breton: 6682	Galician: 7176	Kirghiz: 7589	Pashto, Pushto: 8083	Sundanese: 8385	Wolof: 8779
Bulgarian: 6671	Georgian: 7565	Korean: 7579	Persian: 7065	Swahili: 8387	Xhosa: 8872
Burmese: 7789	German: 6869	Kurdish: 7585	Polish: 8076	Swedish: 8386	Yiddish: 7473
Byelorussian: 6669	Greek: 6976	Laotian: 7679	Portuguese: 8084	Tagalog: 8476	Yoruba: 8979
Cambodian: 7577	Greenlandic: 7576	Latin: 7665	Punjabi: 8065	Tajik: 8471	Zulu: 9085
	Guarani: 7178	Latvian, Lettish: 7686	Quechua: 8185		

On the television

Page

Authorisation Error.	<ul style="list-style-type: none"> You are trying to play the DivX VOD content that was purchased with a different registration code. You cannot play the content on this unit. (DivX) 	30
Cannot finish recording completely.	<ul style="list-style-type: none"> The programme was copy-protected. The HDD or disc may be full. The maximum number of programme has been exceeded. 	— — 21
Cannot playback. TV system is different from the setting. To playback, please change the TV System in Setup.	<ul style="list-style-type: none"> You tried to play a title recorded using a different encoding system from that of the TV system currently selected on the unit. Alter the "TV System" setting on this unit to suit. 	64
Cannot record to the disc.	<ul style="list-style-type: none"> The disc may be dirty or scratched. 	14
Unable to format.		
Cannot play on this unit.	<ul style="list-style-type: none"> You tried to play a non-compatible image. Turn the unit off and re-insert the card. 	13 14
Cannot record. Disc is full.	<ul style="list-style-type: none"> HDD RAM -RW(V) +RW Create space by deleting any unnecessary titles. [Even if you delete recorded content from the DVD-R, DVD-R DL, +R or +R DL there is no increase in disc space. Available space on DVD-RW (DVD-Video format) and +RW increases only when the last recorded title is deleted.] Use a new disc. 	19, 39, 57
Cannot record. Maximum number of titles exceeded.		—
No Disc	<ul style="list-style-type: none"> The disc may be upside down. 	—
No folders.	<ul style="list-style-type: none"> There is no compatible folder in this unit. 	13
No SD CARD No valid SD card. EX68	<ul style="list-style-type: none"> The card is not inserted. If this message is displayed with a compatible card already inserted, turn off the unit, remove and then re-insert the card. The card inserted is not compatible or the card format does not match. 	14 12
Not enough space in the copy destination.	<ul style="list-style-type: none"> Create space by deleting any unnecessary items. Delete one or more items registered on the copy list to ensure that the "Destination Capacity" is not exceeded. 	19, 39, 43, 57 48, 51, 53
This is a non-recordable disc.	<ul style="list-style-type: none"> The unit cannot record on the disc you inserted. Insert a DVD-RAM or unfinalised DVD-R, DVD-RW (DVD-Video format), +R or +RW. 	10
This disc is not formatted properly. Format it using DVD Management in FUNCTION MENU.	<ul style="list-style-type: none"> You inserted an unformatted DVD-RAM, DVD-RW, +R, +R DL or +RW. You cannot directly record to a DVD-R DL and +R DL disc on this unit. Record to the HDD and then copy to the disc. 	57 —
Not enough space on HDD. Space of 4 hours (in SP mode) is necessary. Maximum number of titles is recorded on HDD. Please delete unwanted titles.	<ul style="list-style-type: none"> -R DL +R DL It is not possible to copy when there is not enough free space on the HDD or when the total number of the recorded titles on the HDD and the titles to be copied are greater than 499. Delete unwanted titles from the HDD. 	19
Rental Expired.	<ul style="list-style-type: none"> The DivX VOD content has zero remaining plays. You cannot play it. (DivX) 	31
⊘	<ul style="list-style-type: none"> The operation is prohibited by the unit or disc. 	—

On the unit's display

The following messages or service numbers appear on the unit's display when something unusual is detected during startup and use.

Page

DVD □ (“□” stands for a number.)	<ul style="list-style-type: none"> The remote control and main unit are using different codes. Change the code on the remote control.  <p>Press and hold [OK] and the indicated number button at the same time for more than 5 seconds.</p>	65
GUIDE	<ul style="list-style-type: none"> TV Guide data is being downloaded. 	66
HARD ERR*	<ul style="list-style-type: none"> If there is no change after turning the unit on and off, consult the dealer where the unit was purchased. 	—
NoERAS	<ul style="list-style-type: none"> You cannot delete items on this disc. The disc may be damaged. Use a new disc. 	—
NoREAD	<ul style="list-style-type: none"> The disc is dirty or badly scratched. The unit cannot record, play, or edit. This message may appear when the DVD lens cleaner has finished cleaning. Press [▲ OPEN/CLOSE] on the main unit to eject the disc. 	14 5
NoWRIT	<ul style="list-style-type: none"> You cannot write to this disc. The disc may be damaged. Use a new disc. 	—
PLEASE WAIT*	<ul style="list-style-type: none"> There was a power failure or the AC plug was disconnected while the unit was on. The unit is carrying out its recovery process. This process restores the unit to normal operation. The unit is not broken. Wait until the message disappears. 	—
PROG FULL*	<ul style="list-style-type: none"> There are already 32 timer programmes. Delete unnecessary timer programmes. 	25
REMOVE	<ul style="list-style-type: none"> The USB device is drawing too much power. Remove the USB device. 	—
SP 35:50 LP 151h “SP”, “LP” and the numbers are examples.	<ul style="list-style-type: none"> Available space on the HDD or disc. The example “SP 35:50” is displayed when less than 100 hours are available and the example “LP 151h” is displayed when over 100 hours are available. “SP” and “LP” are recording modes, “35:50” means “35 hours 50 minutes” and “151h” means “151 hours”. 	—
SW-DL	<ul style="list-style-type: none"> The unit is performing a software update. 	66
UNFORMAT*	<ul style="list-style-type: none"> You inserted an unformatted DVD-RAM, DVD-RW, +RW, an unused +R, +R DL, or DVD-RW (DVD-Video format) that has been recorded on other equipment. Format the disc to use it. However all the recorded contents on the disc are deleted. 	57
UNSUPPORT*	<ul style="list-style-type: none"> You have inserted a disc the unit cannot play or record on. You tried to operate with a non-compatible USB memory. 	10–11 12
F74	<ul style="list-style-type: none"> The HDMI connection could not be authenticated due to a transfer malfunction. Consult the dealer where the unit was purchased. 	—
F75	<ul style="list-style-type: none"> The HDMI connection could not be authenticated due to an internal data malfunction. Consult the dealer where the unit was purchased. 	—
U59	<ul style="list-style-type: none"> The unit is hot. The unit switches to standby for safety reasons. Wait for about 30 minutes until the message disappears. Select a position with good ventilation when installing the unit. Do not block the cooling fan on the rear of the unit. 	—
U61	<ul style="list-style-type: none"> (When a disc is not inserted) Displays when a malfunction has occurred during recording, playback or copy. This is displayed when the unit is in the recovery process to return to normal operation; it is not broken. Once the display clears you can use the unit again. 	—
U76	<ul style="list-style-type: none"> HDMI cannot be output because you are connected to a model that does not support copyright protection. 	—
U80 U81 U99	<ul style="list-style-type: none"> The unit fails to operate properly. Press [⏻/] on the main unit to switch the unit to standby mode. Now press [⏻/] on the main unit again to turn the unit on. 	—
U88	<ul style="list-style-type: none"> (When a disc is inserted) Displays when there was something unusual detected with the disc while recording, playback or copy. This is displayed when the unit is in the recovery process to return to normal operation; it is not broken. Once the display clears you can use the unit again. 	76
H□□ or F□□	<ul style="list-style-type: none"> There is something unusual. (The service number displayed after H and F depends on the unit's condition.) Check the unit using the troubleshooting guide. If the service number does not disappear, do the following. <ol style="list-style-type: none"> Disconnect the plug from the household mains socket, wait a few seconds, then reconnect it. Press [⏻/] to turn the power on. (The unit may be fixed.) If the service number does not disappear despite after doing the above, request service from the dealer. Inform the dealer of the service number when requesting service. 	— 76–82
X HOLD	<ul style="list-style-type: none"> The Child Lock function is activated. Press and hold [OK] and [RETURN] at the same time until “X HOLD” disappears. 	67

* The message are alternately displayed.

Troubleshooting guide

Before requesting service, make the following checks. If you are in doubt about some of the check points, or if the solutions indicated in the chart do not solve the problem, consult your dealer for instructions.

The following do not indicate a problem with this unit:

- | | |
|---|---|
| <ul style="list-style-type: none"> ● Regular disc rotating sounds. ● Poor reception due to atmospheric conditions. ● Image disturbance during search. ● Interruptions in reception due to periodic satellite broadcasting breaks. ● Operations are slow to respond in power save mode. ● Operations do not work due to a poor-quality disc. (Try again using a Panasonic disc.) | <ul style="list-style-type: none"> ● The unit freezes due to one of its safety devices being activated. (Press and hold [⏻/⏪] on the main unit for 10 seconds.) ● When the unit is turned on or off, there may be an unexpected sound. This does not indicate a problem with this unit. |
|---|---|

Power

Page

No power.	● Insert the AC mains lead securely into a known active household mains socket.	8, 70, 71
The unit does not turn on pressing [⏻ DVD].		
The unit switches to standby mode.	● One of the unit's safety devices is activated. Press [⏻/⏪] on the main unit to turn the unit on.	—
The power is turned off automatically.	● If you connected this unit to a "HDAVI Control" compatible TV with an HDMI cable, this unit will be automatically set to standby mode when the TV is set to standby mode.	36

Displays

The display is dim.	● Change "FL Display" in the Setup menu.	63
"0:00" is flashing on the unit's display.	● Set the clock.	65
The time recorded on the disc and the available time shown do not add up.	● Times shown may disagree with actual times.	—
The displayed time of this unit is different from the actual recording time or MP3 recording time.	● Available recording space on DVD-RW (DVD-Video format) or +RW increases only when the last recorded title is deleted. It does not increase if other titles are deleted.	—
	● Even if you delete recorded content from the DVD-R, DVD-R DL, +R or +R DL, there is no increase in disc space.	—
	● More disc space than the actual recording time is used after recording or editing the DVD-R, DVD-R DL, +R or +R DL 200 times or more.	—
	● While searching, the elapsed time may not display correctly.	—
The clock is not correct.	● Under adverse reception conditions, etc., the automatic time correction function may not work. In this case, "Automatic" is automatically turned to "Off". If re-setting the Auto Clock Setting does not work, set the time manually.	65
Compared to the actual recorded time, the elapsed time displayed is less. (Only when recording in NTSC)	● The displayed recording/play time is converted from the number of frames at 29.97 frames (equal to 0.999 seconds) to one second. There will be a slight difference between the time displayed and the actual elapsed time (e.g., actual one-hour elapsed time may display as approximately 59 minutes 56 seconds). This does not affect the recording.	—
"U88" is displayed and the disc cannot be ejected.	<ul style="list-style-type: none"> ● The unit is carrying out the recovery process. Do the following to eject the disc. <ol style="list-style-type: none"> 1 Press [⏻/⏪] on the main unit to switch the unit to standby. If the unit doesn't switch to standby, press and hold [⏻/⏪] on the main unit for about 10 seconds. The unit is forcibly switched to standby. 2 While the unit is off, press and hold [■] and [CH ▲] on the main unit at the same time for about 5 seconds. Remove the disc. 	—

TV screen and video

Television reception worsens after connecting the unit.	● This can occur because the signals are being divided between the unit and other equipment. It can be solved by using a signal booster, available from audio-visual suppliers. If it is not solved by using a signal booster, consult the dealer.	—
The digital channel information or control panel does not appear.	<ul style="list-style-type: none"> ● Select the length of time (3–10 sec.) that the "On-Screen Messages" in the Setup menu will be displayed. ● The digital channel information will not appear during playback or recording. ● Analogue broadcasts do not support the digital channel information. ● The control panel is only displayed when connected to a TV with "HDAVI Control 2" or "HDAVI Control 3" function. 	63
The grey background does not appear.	● Select "On" in "Grey Background" in the Setup menu.	63
Picture does not appear during timer recording.	● Timer recordings work regardless whether the unit is on or off. To confirm the timer recording is going to work properly, turn the unit on.	—
The 4:3 aspect ratio picture expands left and right.	● Use the television to change the aspect. If your television does not have that function, set "Progressive" in the Picture menu to "Off".	54
Screen size is wrong.	<ul style="list-style-type: none"> ● Check the settings for "TV Aspect" in the Setup menu. ● If you connect an HDMI cable, set "Aspect for 4:3 Video" to "16:9" in the Setup menu. ● By setting "Aspect for Recording" to "Automatic", there is a chance that the recording will be made using the wrong aspect. Match the aspect settings to the broadcast when recording. ● Set "Rec for High Speed Copy" to "On", and set the "Aspect for Recording" to "4:3". 	64
		64
		61
	It may be possible to adjust the display mode on the TV. Refer to your television's operating instructions.	61
The screen changes automatically.	● The display may turn to the screen saver mode automatically if there is no operation for 5 minutes or more. Press [OK] to return to the previous screen.	—

TV screen and video (continued)		Page	
The recorded title is stretched vertically.	<ul style="list-style-type: none"> ● 16:9 aspect programmes are recorded in 4:3 aspect in the following cases. <ul style="list-style-type: none"> – -R -R DL -RW(V) If you recorded or copied using “EP” or “FR (recordings 5 hours or longer)” recording mode. – If you recorded or copied to a +R, +R DL or +RW. – If you recorded with the “Aspect for Recording” set to “4:3” in the Setup menu. ● When you want to record 16:9 programme in the same aspect, set “Rec for High Speed Copy” to “On”, and set the “Aspect for Recording” to “16:9”. ● By setting “Aspect for Recording” to “Automatic”, there is a chance that the recording will be made using the wrong aspect. Match the aspect settings to the broadcast when recording. It may be possible to adjust the display mode on the TV. Refer to your television’s operating instructions. 	— — 61 61	
	There is a lot of after-image when playing video.	<ul style="list-style-type: none"> ● Set “Playback NR” in the Picture menu to “Off”. 	54
	When playing DVD-Video using progressive output, one part of the picture momentarily appears to be doubled up.	<ul style="list-style-type: none"> ● Set “Progressive” in the Picture menu to “Off”. This problem is caused by the editing method or material used on DVD-Video, but should be corrected if you use interlace output. 	54
There is no apparent change in picture quality when adjusted with the Picture menu in the on-screen menus.	<ul style="list-style-type: none"> ● The effect is less perceivable with some types of video. 	—	
The images from this unit do not appear on the television.	<ul style="list-style-type: none"> ● Make sure that the television is connected to the VIDEO OUT terminal, S VIDEO OUT terminal, COMPONENT VIDEO OUT terminals or HDMI terminal on this unit. ● Make sure that the television’s input setting (e.g., AV 1) is correct. 	8, 68, 70, 71 —	
Picture is distorted.	<ul style="list-style-type: none"> ● Progressive output is set to on but the connected television is not progressive compatible. Press and hold [■] and [▶] (PLAY) on the main unit at the same time for more than 5 seconds to cancel this setting. The setting will change to interlace. ● The unit’s “TV System” setting differs from the TV system used by the disc now playing. While stopped, keep pressing [■] and [▲ OPEN/CLOSE] on the main unit for 5 or more seconds. The system switches from PAL to NTSC or vice versa. ● When this unit is connected with an HDMI cable, use a disc that matches with this unit’s TV system. ● Picture may not be seen when more than 4 devices are connected with HDMI cables. Reduce the number of connected devices. 	— 64 —	
	The picture is distorted during play, or video will not play correctly.	<ul style="list-style-type: none"> ● You may be playing a TV programme recorded with poor reception or unfavorable weather conditions. ● The picture may be distorted or a black screen may appear briefly between recorded titles in the following situations: <ul style="list-style-type: none"> – between titles recorded with different recording modes. – between scenes recorded with different aspect ratios. – between scenes recorded with different resolutions. – between playlist chapters. 	— —

Sound

No sound. Low volume. Distorted sound. Cannot hear the desired audio type.	<ul style="list-style-type: none"> ● Check the connections and the “Digital Audio Output” settings. Check the input mode on the amplifier if you have connected one. ● Press [AUDIO] to select the audio. ● Turn off V.S.S. in the following cases. <ul style="list-style-type: none"> – When using discs that do not have surround sound effects such as Karaoke discs. – When playing bilingual broadcast programmes. ● Audio may not be output due to how files were created. (DivX) ● Audio may not be heard when more than 4 devices are connected with HDMI cables. Reduce the number of connected devices. ● The sound effects will not work when the bitstream signal is output from the HDMI AV OUT terminal or the OPTICAL DIGITAL AUDIO OUT terminal. ● To output audio from a device connected with an HDMI cable, set “Digital Audio Output” to “HDMI and Optical” in the Setup menu. ● Depending on the connected equipment, the sound may be distorted if this unit is connected with an HDMI cable. ● If recording to the HDD or a DVD-RAM when “Rec for High Speed Copy” is set to “On”, you can only record either the main or secondary audio of a bilingual broadcast. If you do not intend to copy the title to a DVD-R, DVD-R DL, DVD-RW (DVD-Video format), +R, +R DL or +RW set “Rec for High Speed Copy” in the Setup menu to “Off”. 	8, 62, 64, 68, 69, 70, 71 28 55 — — —	
	Cannot switch audio.	<ul style="list-style-type: none"> ● You cannot switch the audio in the following cases. <ul style="list-style-type: none"> – When a DVD-R, DVD-R DL, DVD-RW (DVD-Video format), +R, +R DL or +RW disc is in the disc tray while DVD drive is selected. – When the recording mode is XP and “Audio Mode for XP Recording” is set to “LPCM”. – When “Rec for High Speed Copy” is set to “On”. (The default setting is “On”). ● The amplifier is connected using an optical digital cable or an HDMI cable. You cannot switch the audio if “Dolby Digital” is set to “Bitstream”. Set “Dolby Digital” to “PCM” or connect using audio cables. ● There are discs for which audio cannot be changed because of how the disc was created. 	— 62 61 62, 69 —

Operation		Page
<p>Cannot operate the television. The remote control doesn't work.</p>	<ul style="list-style-type: none"> ● Change the manufacturer code. Some televisions cannot be operated even if you change the code. ● The remote control and main unit are using different codes. Change the code on the remote control. 	<p>67 65</p>
	<div data-bbox="497 250 710 324" style="display: inline-block; vertical-align: middle;"> </div> <p style="display: inline-block; vertical-align: middle;">Press and hold [OK] and the indicated number button at the same time for more than 5 seconds.</p> <ul style="list-style-type: none"> ● The batteries are depleted. Replace them with new ones. ● You are not pointing the remote control at the main unit's remote control signal sensor during operation. ● Coloured glass may obstruct the signal reception/transmission. ● Don't place the signal sensor in direct sunlight or in areas that may be subject to sunlight exposure. ● It may be necessary to set the code on the remote control again after changing the batteries. ● It may be necessary to set the manufacturer code again after changing the batteries. ● The child lock function is activated. 	<p>4 4 — — 65 67 67</p>
<p>The unit is on but cannot be operated.</p>	<ul style="list-style-type: none"> ● Recording drive or playback drive has not been selected properly. ● Some operations may be prohibited by the disc. ● The unit is hot ("U59" appears on the display). Wait for "U59" to disappear. ● One of the unit's safety devices may have been activated. <p>Reset the unit as follows:</p> <ol style="list-style-type: none"> 1 Press [⏻/⏪] on the main unit to switch the unit to standby. If the unit doesn't switch to standby, press and hold [⏻/⏪] on the main unit for about 10 seconds. The unit is forcibly switched to standby. Alternatively, disconnect the AC mains lead, wait one minute, then reconnect it. 2 Press [⏻/⏪] on the main unit to switch it on. If the unit still cannot be operated, consult the dealer. 	<p>16, 17 — — —</p>
<p>Cannot eject disc.</p>	<ul style="list-style-type: none"> ● The unit is recording. ● The unit may have a problem. While the unit is off, press and hold [■] and [CH ^] on the main unit at the same time for about 5 seconds. Remove the disc and consult the dealer. If the Child Lock function is activated, above operation does not work. Cancel the Child Lock function. 	<p>— 67</p>
<p>Cannot tune channels. Cannot download channel presets from the television.</p>	<ul style="list-style-type: none"> ● Check the connections. ● You must connect to a VIERA Link (HDAVI Control 3) compatible TV with a HDMI cable to download channel presets. 	<p>8, 70, 71 —</p>
<p>Startup is slow.</p>	<ul style="list-style-type: none"> ● Make sure that "Quick Start" is set to "On". ● Startup takes time in the following situations: <ul style="list-style-type: none"> – A disc other than a DVD-RAM is inserted. – The clock is not set. – Immediately after a power failure or the AC mains lead is connected. – When the unit is connected with an HDMI cable. 	<p>65 —</p>

Cannot record. Cannot copy.	• You haven't inserted a disc or the disc you inserted cannot be recorded on. Insert a disc the unit can record onto.	10
	• The disc is unformatted. Format the disc. RAM -RW(V) +R +R DL +RW	57
	• The write-protect tab on the cartridge is set to PROTECT, or the disc is protected with DVD Management.	56
	• Some programmes have limitations on the number of times they can be recorded (CPRM).	84
	• You cannot record when there is not enough space or when the number of titles has reached its limit. Delete unwanted titles or use a new disc.	19, 39, 57
	• You cannot directly record to a DVD-R DL or +R DL disc on this unit. Record to the HDD and then copy to the disc.	—
	• -R DL +R DL In the following situations, you cannot copy. Delete unnecessary titles from the HDD and then copy. – If there is not enough space available on the HDD (If you will copy titles from the HDD to a blank disc and fill the entire disc, HDD disc space equivalent to 4 hours of SP mode recording is necessary). – If the number of recorded titles and the number of titles to be copied has exceeded 499.	19, 39, 57
	• You cannot record and copy on finalised discs. However, you can record and copy again if you format DVD-RW.	—
	• Due to peculiarities of DVD-R, DVD-R DL, DVD-RW (DVD-Video format), +R, +R DL and +RW you may be unable to record onto them if you either insert and remove the disc or switch the unit on and off while a disc is loaded, a total of fifty times.	—
	• DVD-R, DVD-R DL, DVD-RW (DVD-Video format), +R, +R DL and +RW recorded on this unit may not be recordable on other Panasonic DVD Recorders.	—
• This unit cannot record NTSC signals to discs that already have PAL signal recordings. (However, both types of programmes can be recorded onto the HDD.) Play of discs recorded with both PAL and NTSC on another unit is not guaranteed.	—	
• Some broadcasts are copyright protected.	—	
Cannot record from external equipment.	• Check that the connection is correct. • Select the input channel for the equipment you have connected.	23, 70, 71 —
Timer recording does not work properly.	• The timer programme is incorrect or different timer programme times overlap. Correct the programme.	25
	• The programme is not in timer recording standby. (The timer icon "Ⓞ" in the timer recording list is not on.)	25
	• Set the clock.	65
	• The programme information in the TV Guide system may not be correct. It is recommended to modify the start and end times to allow a margin of a few minutes.	24
Timer recording does not stop even when [■] is pressed.	• Make sure that the recording drive is selected. Press [DRIVE SELECT] to select the recording drive.	25
	• If you start recording immediately after turning on the unit while "Quick Start" is set to "On", you cannot then stop recording for a few seconds.	—
A part or whole of a recorded title has been lost.	• If there is a power failure or the plug is disconnected from the household mains socket while recording or editing, the title may be lost or the HDD/disc may become unusable. You will have to format the disc (HDD RAM -RW(V) +RW) or use a new disc. We cannot offer any guarantee regarding lost programmes or discs.	— 57
	• There was a programme change after timer recording was set but the recorded title still has the old programme name.	—
The programme name and the recorded title do not match.	• When recording to the HDD, set "Rec for High Speed Copy" to "On" in the Setup menu. (The default setting is "On").	61
	• In the following cases, high speed mode does not work, even if the titles were recorded with "Rec for High Speed Copy" set to "On". – +R +R DL +RW If recorded in "EP" or "FR (recordings 5 hours or longer)" mode. – +R +R DL +RW If recorded in 16:9 aspect. – -R -R DL -RW(V) If recorded in 16:9 aspect using "EP" mode or "FR" (recordings 5 hours or longer) mode.	—
	• +R +R DL +RW Titles recorded on other Panasonic DVD recorders with "Rec for High Speed Copy" set to "On", and then copied to the HDD on this unit may not copy to +R, +R DL or +RW discs with high-speed copy.	—
	• Use a disc that is compatible with high speed recording. Even if the disc is high speed recording compatible, the maximum speed may not be possible due to the condition of the disc.	—
When copying, it takes a long time even when high speed mode is selected.	• It takes longer than normal to copy many titles.	—
	• You cannot high speed copy to DVD-R titles longer than 6 hours when using other Panasonic DVD Recorders that are not compatible with EP (8 Hours) mode recording.	—
An unusually loud sound is coming from the rotating DVD-R, etc.	• When recording or high speed copying to a DVD-R, DVD-R DL, DVD-RW (DVD-Video format), +R, +R DL and +RW the sound of the disc rotating may be louder than normal, however, this is not a problem.	—
The DV automatic recording function does not work.	• If images cannot be recorded or if the recording is aborted, check the connections and DV equipment settings.	23
	• You cannot start recording until the images from the DV equipment appear on the television.	—
	• Recording may not be performed as desired if the time codes on the tape in the DV equipment are not successive.	—
	• Depending on the equipment, the DV automatic recording may not operate properly.	—
	• The audio/video recordings are recorded on other than a DV tape.	23

Play

		Page
Play fails to start even when [▶] (PLAY) is pressed. Play starts but then stops immediately.	<ul style="list-style-type: none"> • Insert the disc correctly with the label facing up. 	14
	<ul style="list-style-type: none"> • The disc is dirty. 	14
	<ul style="list-style-type: none"> • You tried to play a blank disc or disc unplayable on this unit. 	10–11
	<ul style="list-style-type: none"> • You tried to play a +RW that needs to be finalised on the equipment used for recording. 	—
	<ul style="list-style-type: none"> • You may be able to copy a “One time only recording” title that was recorded to DVD-RAM using a different Panasonic DVD Recorder to this unit’s HDD, but play is not possible due to copyright protection. 	—
	<ul style="list-style-type: none"> • When recording to DVD-RAM using “EP (8 Hours)” mode, play may not be possible on DVD players that are compatible with DVD-RAM. In this case use “EP (6 Hours)” mode. 	61
Audio and video momentarily pause.	<ul style="list-style-type: none"> • This occurs between playlist chapters. 	—
	<ul style="list-style-type: none"> • This occurs between chapters and with partially deleted titles on finalised DVD-R, DVD-R DL, DVD-RW (DVD-Video format), +R, +R DL and +RW that have been copied using the high speed mode. 	—
	<ul style="list-style-type: none"> • This occurs as scenes change during Quick View. • R DL +R DL When playing a title recorded on both layers, the unit automatically switches between layers and plays the title in the same way as a normal programme. However, video and audio may momentarily cut out when the unit is switching layers. 	10
DVD-Video is not played.	<ul style="list-style-type: none"> • You have set a ratings level to limit DVD-Video play. Change this setting. • Ensure disc is for the correct DVD-Video region number, and is not defective. 	61 Cover
Alternative soundtrack and subtitles cannot be selected.	<ul style="list-style-type: none"> • The languages are not recorded on the disc. • You may not be able to use the on-screen menus to change the soundtrack and subtitles on some discs. Use the disc’s menus to make changes. 	— 16
No subtitles.	<ul style="list-style-type: none"> • Subtitles are not recorded on the disc. • Turn the subtitles on. Set “Subtitle” on the on-screen menu to “On”. 	— 54
Angle cannot be changed.	<ul style="list-style-type: none"> • Angles can only be changed during scenes where different angles are recorded. 	—
You have forgotten your ratings password. You want to cancel the ratings level.	<ul style="list-style-type: none"> • The ratings level returns to the factory preset. While the disc tray is open, press [DRIVE SELECT] to select the DVD drive, then press and hold [● REC] and [▶] (PLAY) on the main unit at the same time for 5 or more seconds (“INIT” will appear on the unit’s display). 	—
Quick View does not work.	<ul style="list-style-type: none"> • This does not work when audio is other than Dolby Digital. • This does not work when recording is in XP or FR mode. 	— —
The resume play function does not work.	<ul style="list-style-type: none"> • Memorized positions are cancelled when <ul style="list-style-type: none"> – press [■] several times. – open the disc tray. – SD (EX88) CD VCD USB turn off the power. – if a recording or timer recording was executed. 	—
The Video CD picture does not display properly.	<ul style="list-style-type: none"> • When connecting to Multi-system TV, select “NTSC” in “TV System” in the Setup menu. • When connecting to PAL TV, the lower part of the picture cannot be displayed correctly during search. 	64 —
Time Slip, Manual Skip, etc. does not work.	<ul style="list-style-type: none"> • These functions do not work with finalised discs. • Time Slip does not work when the unit’s “TV System” settings are different from the title recorded on the disc. 	— 64
It takes time before play starts.	<ul style="list-style-type: none"> • This is normal on DivX video. (DivX) 	—
Picture stops.	<ul style="list-style-type: none"> • Picture may stop if the DivX files are greater than 2 GB. (DivX) 	—
Cannot see the beginning of the title played.	<ul style="list-style-type: none"> • (If connecting to a TV that supports VIERA Link with an HDMI cable) When [▶] (PLAY) is pressed on this unit’s remote control, you may not be able to see the beginning of the title played until the picture is displayed on the TV. Using [◀◀], return to the beginning of the title. 	—

Edit

Available disc space does not increase even after deleting a title.	<ul style="list-style-type: none"> • Available disc space does not increase after deleting on DVD-R, DVD-R DL, +R or +R DL. • Disc space increases only when the last recorded title is deleted on DVD-RW (DVD-Video format) and +RW. The disc space does not increase when any other titles are deleted. 	19 —
Cannot edit.	<ul style="list-style-type: none"> • You may not be able to edit on the HDD if there is no available space. Delete any unwanted titles to create empty space. 	19
Cannot format.	<ul style="list-style-type: none"> • The disc is dirty. Wipe with a damp cloth and then wipe dry. • You tried formatting a disc that you may not be able to use in this unit. 	14 10–11
Cannot create chapters.	<ul style="list-style-type: none"> • The unit writes the chapter division information to the disc when you turn it off or remove the disc. The information is not written if there is an interruption to the power before this. 	—
Cannot mark the start point or the end point during “Partial Delete” operation.	<ul style="list-style-type: none"> • These operations are not possible with still pictures. • You cannot set points if they are too close to each other. You cannot set an end point before a start point. 	— —
Cannot delete chapters.	<ul style="list-style-type: none"> • When the chapter is too short to delete, use “Combine Chapters” to make the chapter longer. 	39
Cannot create a playlist.	<ul style="list-style-type: none"> • You cannot select all the chapters at once in a title if the title also includes still pictures. Select them individually. 	—

Music

Tracks could not be copied to the HDD.	<ul style="list-style-type: none"> • If there are copyright protected tracks such as SCMS restrictions, they will not be copied. • Recording from CDs that do not conform to CD-DA specifications (copy control CDs, etc.) cannot be guaranteed. • Bonus tracks may not be copied. 	— — —
ID3 tag of a MP3 file is not completely displayed.	<ul style="list-style-type: none"> • Only the track name and artist name can be displayed with this unit. 	—

Still pictures

Page

Cannot display Direct Navigator screen.	<ul style="list-style-type: none"> This screen cannot be displayed during recording or copy. 	—
Cannot edit or format a card. (EX88)	<ul style="list-style-type: none"> Release the card's protection setting. (With some cards, the "Write Protection Off" message sometimes appears on the screen even when protection has been set.) 	56
The contents of the card cannot be read. (EX88)	<ul style="list-style-type: none"> Remove the card from the slot and then insert again. If this does not solve the problem, turn off and turn on the unit again. 	—
	<ul style="list-style-type: none"> The card format is not compatible with the unit. (The contents on the card may be damaged.) This unit is compatible with SD Memory Cards that meet SD Card Specifications FAT12 and FAT16 formats, as well as SDHC Memory Cards in FAT32 format. 	12, 13
	<ul style="list-style-type: none"> The card contains a folder structure and/or file extensions that are not compatible with this unit. 	12
	<ul style="list-style-type: none"> You can use SD Memory Cards with capacities from 8 MB to 2 GB and SDHC Memory Cards with capacities from 4 GB to 16 GB. This unit cannot play AVCHD format motion pictures or MPEG4 on an SD card. 	—
Copying, deleting and setting protection takes a long time. (EX88)	<ul style="list-style-type: none"> When there are a lot of folders and files, it may sometimes take a few hours. When repeating copying or deleting, it may sometimes take a long time. Format the disc or card. 	57

USB

The contents of the USB memory cannot be read.	<ul style="list-style-type: none"> Remove the USB memory from the USB port and then insert again. If this does not solve the problem, turn off and turn on the unit again. 	—
	<ul style="list-style-type: none"> Check that the USB memory is inserted correctly. 	14
	<ul style="list-style-type: none"> The format of the USB memory or of its contents is not compatible with the unit. (The contents on the USB memory may be damaged.) 	12, 13
	<ul style="list-style-type: none"> The USB memory contains a folder structure and/or file extensions that are not compatible with this unit. 	13
	<ul style="list-style-type: none"> Turn off and then turn on the unit again. 	—
	<ul style="list-style-type: none"> USB memories connected using a USB extension cable or a USB hub may not be recognized by this unit. 	—
	<ul style="list-style-type: none"> Some USB memories cannot be used with this unit. If inserted during playback, recording or copying etc., the USB memory may not be recognized by this unit. 	12

TV Guide

The TV Guide System does not receive any data.	<ul style="list-style-type: none"> Check whether the clock is properly set. 	65
	<ul style="list-style-type: none"> If signal quality is bad (ghost images or limited reception), the TV Guide system may not be able to receive any data. 	—
"No Data" is displayed for some or all stations.	<ul style="list-style-type: none"> Some stations are not supported by the TV Guide system. 	—
	<ul style="list-style-type: none"> Analogue broadcasts are not supported by the TV Guide system. 	—
	<ul style="list-style-type: none"> Programme the Timer recording manually or via G-CODE. 	24
The TV Guide information is not displayed properly.	<ul style="list-style-type: none"> There was a programme change. Check the current programme, e.g. on the Web site for the TV Guide system provider or station provider. 	—
	<ul style="list-style-type: none"> Programme information about analogue broadcasts is not displayed. 	—
The TV Guide data transfer was interrupted.	<ul style="list-style-type: none"> The TV Guide system shows the data that was received up to the interruption. The programme information may be incomplete. 	—
The TV Guide data is not updated.	<ul style="list-style-type: none"> Make sure that the time is set correctly. Check whether "Off" is set under "TV Guide Download in Standby" and change the setting in the Setup menu. 	66

Digital broadcast

Digital broadcasts cannot be received.	<ul style="list-style-type: none"> Digital broadcast may not have started in your region yet. 	—
	<ul style="list-style-type: none"> The aerial may not be pointing in the direction of the TV station, or the direction of the aerial may have changed due to strong winds or vibration. If problem persists consult your local TV aerial installer. 	—
After DVB Auto-Setup only some or no DVB channels are found.	<ul style="list-style-type: none"> Check to ensure your area is covered by DVB transmissions. 	—
	<ul style="list-style-type: none"> Check that the aerial and antenna cable are designed for DVB. Use the included RF coaxial cable as shown in STEP 1. For your safety, the aerial and cable should be inspected/installed by a licenced installer that should comply with Australian Standard AS1417.1. If you live within 5-10 km of DVB transmission towers, a combined VHF/UHF aerial should be adequate. Outside this area, separate VHF and UHF aerials provide superior reception performance. 	8
	<ul style="list-style-type: none"> If you live in a unit or apartment, check to ensure the Master Antenna TV (MATV) system is designed for analogue and DVB-T reception. Please consult your body corporate. 	—
Picture regularly breaks up on some channels. "No Signal" message is displayed.	<ul style="list-style-type: none"> Check "Signal Condition". If "Signal Quality" or "Signal Strength" are displayed in red or constantly changing, check aerial. If problem persists consult your local TV aerial installer. 	60
	<ul style="list-style-type: none"> Check that the aerial and antenna cable are designed for DVB. Use the included RF coaxial cable as shown in STEP 1. For your safety, the aerial and cable should be inspected/installed by a licenced installer that should comply with Australian Standard AS1417.1. 	8
	<ul style="list-style-type: none"> Interference (known as impulse noise) from household appliances such as light switches, fridges etc. may cause picture break up and/or audio distortion. Use a high quality quad shielded coaxial cable fly lead between this unit and antenna wall socket to minimise impulse noise pickup. If problem persists consult your local TV aerial installer. 	—
	<ul style="list-style-type: none"> Check aerial connection. 	—
	<ul style="list-style-type: none"> Adjust the aerial reception with "DVB Manual Tuning" in the Setup menu. 	59
Picture very infrequently breaks up on some or all channels.	<ul style="list-style-type: none"> Electrical atmospheric interference caused by local or distant lightning storms or heavy rain with wind in "leafy" locations may cause pictures to break up and audio to mute or distort momentarily. 	—
	<ul style="list-style-type: none"> Impulse noise interference from an infrequently used electrical appliance, or a passing vehicle or lawn mower with a "noisy" ignition system. 	—

VIERA Link

Page

<p>VIERA Link doesn't work.</p>	<ul style="list-style-type: none"> ● Check the HDMI cable connection. Check that "HDMI" is displayed on the front display when the power for the main unit is set to On. ● Make sure that "VIERA Link" is set to "On". ● Check the "HDAVI Control" settings on the connected device. ● Some functions may not work if depending on the version of "HDAVI Control" of the connected equipment. This unit supports "HDAVI Control 3" functions. ● If the connection for the equipment connected with HDMI was changed, or if there was a power failure or the plug was removed from the household mains socket, "HDAVI Control" may not work. In this case, perform the following operations. 1 When the HDMI cable is connected to all equipment with the power on, turn the TV (VIERA) on again. 2 Change the TV (VIERA) settings for the "HDAVI Control" function to off, and then set to on again. (For more information, see the VIERA operating instructions.) 3 Switch the VIERA input to HDMI connection with this unit, and after this unit's screen is displayed check that "HDAVI Control" is working. 	<p>—</p> <p>64</p> <p>—</p> <p>—</p>
<p>The operation on this unit (music playback etc.) is interrupted.</p>	<ul style="list-style-type: none"> ● The operation on this unit may be interrupted when you press buttons on the TV remote control that do not work for VIERA Link functions. 	<p>—</p>

To reset this unit

<p>To return all the settings other than the main ones to the factory preset</p>	<ul style="list-style-type: none"> ● Select "Yes" in "Shipping Condition" in the Setup menu. All the settings except for the ratings level, ratings password and clock settings return to the factory preset. The timer recording programmes are also cancelled. ● Select "Yes" in "Default Settings" in the Setup menu. All the settings other than the tuning settings, clock settings, region settings, disc language settings, ratings level, ratings password, remote control code, return to the factory presets. ● Press and hold [v CH] and [CH ^] on the main unit until the Auto-Setup screen appears. All the settings except for the ratings level, ratings password and clock settings return to the factory preset. The timer recording programmes are also cancelled. 	<p>66</p> <p>66</p> <p>—</p>
<p>To reset the ratings level settings</p>	<ul style="list-style-type: none"> ● While the disc tray is open, press [DRIVE SELECT] to select the DVD drive, then press and hold [● REC] and [▶] (PLAY) on the main unit at the same time for 5 or more seconds. 	<p>—</p>
<p>To restore the unit if it freezes due to one of the safety devices being activated</p>	<ul style="list-style-type: none"> ● Press and hold [⏻/] on the main unit for 10 seconds. (The settings remain.) 	<p>—</p>

Other

<p>After performing an update, you can no longer receive broadcasts.</p>	<ul style="list-style-type: none"> ● Depending on the content of the update, some settings may have returned to the preset values. Fix the settings again. 	<p>—</p>
---	---	----------

Recording system
 DVD-RAM : DVD Video Recording format
 DVD-R : DVD-Video format
 DVD-R DL (Dual Layer) : DVD-Video format
 DVD-RW : DVD-Video format
 +R
 +R DL (Double Layer)
 +RW

Recordable discs
 DVD-RAM: 2X SPEED (Ver. 2.0),
 2-3X SPEED (Ver. 2.1), 2-5X SPEED (Ver. 2.2)
 DVD-R: 1X SPEED (Ver. 2.0), 1-4X SPEED (Ver. 2.0),
 1-8X SPEED (Ver. 2.0), 1-16X SPEED (Ver. 2.1)
 DVD-R DL: 2-4X SPEED (Ver. 3.0), 2-8X SPEED (Ver. 3.0)
 DVD-RW: 1X SPEED (Ver. 1.1), 1-2X SPEED (Ver. 1.1),
 2-4X SPEED (Ver. 1.2), 2-6X SPEED (Ver. 1.2)
 +R: 2.4X SPEED (Ver. 1.0), 2.4-4X SPEED (Ver. 1.1),
 2.4-8X SPEED (Ver. 1.2), 2.4-16X SPEED (Ver. 1.3)
 +R DL: 2.4X SPEED (Ver. 1.0), 2.4-8X SPEED (Ver. 1.1)
 +RW: 2.4X SPEED (Ver. 1.1), 2.4-4X SPEED (Ver. 1.2)

Recording time
 Maximum 8 hours (using 4.7 GB disc)
 XP: Approx. 1 hour, SP: Approx. 2 hours
 LP: Approx. 4 hours, EP: Approx. 6 hours/8 hours

EX78
 Maximum Approx. 441 hours with 250 GB HDD (EP 8 hours mode)
 XP: Approx. 55 hours, SP: Approx. 110 hours
 LP: Approx. 221 hours, EP: Approx. 331 hours/441 hours

EX88
 Maximum Approx. 712 hours with 400 GB HDD (EP 8 hours mode)
 XP: Approx. 89 hours, SP: Approx. 178 hours
 LP: Approx. 357 hours, EP: Approx. 534 hours/712 hours

Playable discs
 DVD-RAM : DVD Video Recording format
 DVD-R : DVD-Video format, DivX*1
 DVD-R DL (Dual Layer) : DVD-Video format, DivX*1
 DVD-RW : DVD-Video format, DVD Video Recording format
 +R, +R DL (Double Layer), +RW
 DVD-Video, CD-Audio (CD-DA), Video CD
 CD-R/CD-RW : CD-DA*1, Video CD*1, MP3*1, JPEG*1, DivX*1

Internal HDD capacity
EX78 250 GB
EX88 400 GB

Optical pick-up
 System with 1 lens, 2 integration units
 (662 nm wavelength for DVDs, 780 nm wavelength for CDs)

LASER specification
 Class 1 LASER Product (Pickup)
 Wave length:
 CD 780 nm wave length
 DVD 662 nm wave length
 Laser power:
 No hazardous radiation is emitted with the safety protection

Audio
 Recording system: Dolby Digital 2ch, Linear PCM (XP mode)
 Audio in: AV1/AV2 (21 pin), AV3/AV4 (pin jack)
 Input level: Standard: 0.5 Vrms, Full scale: 2.0 Vrms at 1 kHz
 Input impedance: More than 10 kΩ
 Audio out: AV1/AV2 (21 pin), Audio Out (pin jack)
 Output level: Standard: 0.5 Vrms, Full scale: 2.0 Vrms at 1 kHz
 Output impedance: Less than 1 kΩ
 Digital audio out: Optical terminal (PCM, Dolby Digital, DTS, MPEG)

HDMI Output
 19 pin type A: 1 pc
 HDMI™ (V.1.3 with Deep Colour)

• This unit supports "HDAVI Control 3" function.

Video
 Video system: PAL colour signal, 625 lines, 50 fields
 NTSC colour signal, 525 lines, 60 fields
 Recording system: MPEG2 (Hybrid VBR)
 Video in (PAL/NTSC):
 AV1/AV2 (21 pin), AV3/AV4 (pin jack) 1 Vp-p 75 Ω, termination
 S-Video in (PAL/NTSC):
 AV2 (21 pin), AV3/AV4 (S terminal) 1 Vp-p 75 Ω, termination
 Video out (PAL/NTSC):
 AV1/AV2 (21 pin), Video Out (pin jack) 1 Vp-p 75 Ω, termination
 S-Video out (PAL/NTSC):
 AV1 (21 pin), S-Video Out (S terminal) 1 Vp-p 75 Ω, termination
 RGB out (PAL/NTSC):
 AV1 (21 pin) 0.7 Vp-p (PAL) 75 Ω, termination

Component video output (NTSC 480p/480i, PAL 576p/576i)
 Y: 1.0 Vp-p 75 Ω, termination
 Pb: 0.7 Vp-p 75 Ω, termination
 Pr: 0.7 Vp-p 75 Ω, termination

Television system

Tuner system	Channel coverage
PAL-B Australia	VHF: 0-12 UHF: 28-69 CATV: 45 MHz-470 MHz
DVB-T Australia	VHF: 6-12 UHF: 27-69

RF converter output: Not provided

SD Card (EX88)

Slot: SD Memory Card slot: 1 pc
 Compatible media: SD Memory Card*2, SDHC Memory Card,
 MultiMediaCard
 Format: FAT12, FAT16*3
 (In case of SD Memory Card/MultiMediaCard)
 FAT32*3 (In case of SDHC Memory Card)

Still picture (JPEG)
 Image file format:
 JPEG conforming DCF (Design rule for Camera File system),
 Number of pixels: Between 34 × 34 and 6144 × 4096
 sub sampling; 4:2:2 or 4:2:0
 Thawing time: Approx. 1.9 sec (6 M pixels, JPEG)

Video (SD Video)*4
 Codec: MPEG 2 (SD-Video Entertainment Video Profile)
 File Format: SD-Video format conforming

DV input
 IEEE 1394 Standard, 4 pin : 1 pc

USB port
 Type A : 1 pc
 USB standard: **EX88** USB 2.0 High Speed
EX78 USB 2.0 Full Speed
 Format: FAT16, FAT32

Video (SD Video)*4 (**EX88**)
 Codec: MPEG 2 (SD-Video Entertainment Video Profile)
 File Format: SD-Video format conforming

Others
 Region code: # 4
 Operating temperature: 5 °C to 40 °C
 Operating humidity range: 10 % to 80 % RH (no condensation)
 Power supply: AC 220 to 240 V, 50 Hz
 Power consumption: Approx. 36 W
 Dimensions (W×H×D): 430 mm×59 mm×326 mm
 Mass: Approx. 4.2 kg

Power consumption in standby mode:
Approx. 2 W (Power Save mode)
Approx. 15 W (Quick Start mode)

Note

Specifications are subject to change without notice.

- *1 Finalising is necessary for compatible playback.
 - *2 Includes miniSD cards. (A miniSD adaptor needs to be inserted.)
 Includes microSD cards. (A microSD adaptor needs to be inserted.)
 - *3 Long file name is unsupported.
 - *4 Video Recording conversion and transfer is possible from card or
 Panasonic digital video camera with HDD etc, to HDD or
 DVD-RAM disc. After Video Recording conversion and transfer to
 HDD or DVD-RAM disc, the playback is possible.
- Useable capacity will be less. (SD card)

Bitstream

This is the digital form of multi-channel audio data (e.g., 5.1 channel) before it is decoded into its various channels.

CPRM (Content Protection for Recordable Media)

CPRM is technology used to protect broadcasts that are allowed to be recorded only once. Such broadcasts can be recorded only with CPRM compatible recorders and discs.

Decoder

A decoder restores the coded audio signals on DVDs to normal. This is called decoding.

DivX

DivX is a popular media technology created by DivX, Inc. DivX media files contain highly compressed video with high visual quality that maintains a relatively small file size.

Dolby Digital

This is a method of coding digital signals developed by Dolby Laboratories. Apart from stereo (2-channel) audio, these signals can also be multi-channel audio. A large amount of audio information can be recorded on one disc using this method.

When recording on this unit Dolby Digital (2 channel) is the default audio.

Down-mixing

This is the process of remixing the multi-channel audio found on some discs into two channels. It is useful when you want to listen to the 5.1-channel audio recorded on DVDs through your television's speakers. Some discs prohibit down-mixing and this unit can then only output the front two channels.

Drive

In the instance of this unit, this refers to the hard disk (HDD), disc (DVD) and SD card (SD) (EX88). These perform the reading and writing of data.

DTS (Digital Theater Systems)

This surround system is used in many movie theaters. There is good separation between the channels, so realistic sound effects are possible.

Dynamic range

Dynamic range is the difference between the lowest level of sound that can be heard above the noise of the equipment and the highest level of sound before distortion occurs.

Dynamic range compression means reducing the gap between the loudest and softest sounds. This means you can listen at low volumes but still hear dialogue clearly.

Film and video

DVD-Videos are recorded using either film or video. This unit can determine which type has been used, then uses the most suitable method of progressive output.

Film: Recorded at 25 frames per second (PAL discs) or 24 frames per second (NTSC discs). (NTSC discs recorded at 30 frames per second as well.)
Generally appropriate for motion picture films.

Video: Recorded at 25 frames/50 fields per second. (PAL discs) or 30 frames/60 fields per second (NTSC discs).
Generally appropriate for TV drama programmes or animation.

Finalise

A process that makes play of a recorded CD-R, CD-RW, DVD-R, etc. possible on equipment that can play such media. You can finalise DVD-R, DVD-R DL, DVD-RW (DVD-Video format), +R, +R DL on this unit.

After finalising, the disc becomes play-only and you can no longer record or edit. However, finalised DVD-RW can be formatted for recording again.

Folder

This is a place on the hard disk, disc or SD card (EX88) where groups of data are stored together. In the case of this unit, it refers to the place where still pictures (JPEG) and MPEG2 (EX88) are stored.

Formatting

Formatting is the process of making media such as DVD-RAM recordable on recording equipment.
You can format DVD-RAM, DVD-RW (only as DVD-Video format), +RW, SD cards (EX88) and the HDD or unused +R and +R DL on this unit.
Formatting permanently deletes all contents.

Frames and fields

Frames refer to the single images that constitute the video you see on your television. Each frame consists of two fields.



- A frame still shows two fields, so there may be some blurring, but picture quality is generally better.
- A field still shows less picture information so it may be rougher, but there is no blurring.

HDD (Hard disk drive)

This is a mass data storage device used in computers, etc. A disk with a surface that has been treated with magnetic fluid is spun and a magnetic head is brought in close proximity to facilitate the reading and writing of large amounts of data at high speed.

HDMI (High-Definition Multimedia Interface)

Unlike conventional connections, it transmits uncompressed digital video and audio signals on a single cable. This unit supports high-definition video output [720p (750p), 1080i (1125i), 1080p (1125p)] from HDMI AV OUT terminals. To enjoy high-definition video a high definition compatible television is required.

JPEG (Joint Photographic Experts Group)

This is a system used for compressing/decoding colour still pictures. If you select JPEG as the storage system on digital cameras, etc., the data will be compressed to 1/10–1/100 of its original size. The benefit of JPEG is less deterioration in picture quality considering the degree of compression.

LPCM (Linear PCM)

These are uncompressed digital signals, similar to those found on CDs.

MPEG2 (Moving Picture Experts Group)

A standard for efficiently compressing and expanding colour video. MPEG2 is a compression standard used for DVD and satellite based digital broadcasting. This unit records programmes using MPEG2. SD Video files shot with a Panasonic SD video camera, etc. can be copied to the HDD or a DVD-RAM disc.

MP3 (MPEG Audio Layer 3)

An audio compression method that compresses audio to approximately one tenth of its size without any considerable loss of audio quality.

Pan&Scan/Letterbox

In general, DVD-Video are produced with the intention that they be viewed on a widescreen television (16:9 aspect ratio), so images often don't fit regular (4:3 aspect ratio) televisions. Two styles of picture, "Pan & Scan" and "Letterbox", deal with this problem.

Pan & Scan: The sides are cut off so the picture fills the screen.



Letterbox: Black bands appear at the top and bottom of the picture so the picture itself appears in an aspect ratio of 16:9.



Playback control (PBC)

If a Video CD has playback control, you can select scenes and information with menus.
(This unit is compatible with version 2.0 and 1.1.)

Progressive/Interlace

The PAL video signal standard has 576 (or 625) interlaced (i) scan lines, whereas progressive scanning, called 576p (or 625p), uses twice the number of scan lines. For the NTSC standard, these are called 480i (or 525i) and 480p (or 525p) respectively. Using progressive output, you can enjoy the high-resolution video recorded on media such as DVD-Video.

Your television must be compatible to enjoy progressive video. Panasonic televisions with 576 (625)/50i · 50p, 480 (525)/60i · 60p input terminals are progressive compatible.

Protection

You can prevent accidental deletion by setting writing protection or deletion protection.

RGB

This refers to the three primary colours of light, red (R), green (G), and blue (B) and also the method of producing video that uses them. By dividing the video signal into the three colours for transmission, noise is reduced for even higher quality images.

Sampling frequency

Sampling is the process of converting the heights of sound wave (analog signal) samples taken at set periods into digits (digital encoding). Sampling frequency is the number of samples taken per second, so larger numbers mean more faithful reproduction of the original sound.

Signal Quality

This is the guide for checking the aerial direction. The numbered values displayed do not indicate the strength of the signal, but the quality of the signal (the signal to noise ratio, or "S/N"). The channels you can receive are affected by weather conditions, seasons, time (day/night), region, length of the cable that is connected to the aerial, etc.

Thumbnail

This refers to a miniature representation of a picture used to display multiple pictures in the form of a list.

1080i

In one high definition image, 1080 (1125) alternating scan lines pass every 1/50th of a second to create an interlace image. Because 1080i (1125i) more than doubles current television broadcasts of 480i (525i), the detail is much clearer and creates a more realistic and rich image.

1080p

In one high definition image, 1080 (1125) scan lines pass at the same time every 1/50th of a second to create a progressive image. Since progressive video does not alternate scan lines like interlace, there is a minimal amount of screen flicker.

720p

In one high definition image, 720 (750) scan lines pass at the same time every 1/50th of a second to create a progressive image. Since progressive video does not alternate scan lines like interlace, there is a minimal amount of screen flicker.

Safety precautions

Placement

Set the unit up on an even surface away from direct sunlight, high temperatures, high humidity, and excessive vibration. These conditions can damage the cabinet and other components, thereby shortening the unit's service life.

Do not place heavy items on the unit.

Voltage

Do not use high voltage power sources. This can overload the unit and cause a fire.

Do not use a DC power source. Check the source carefully when setting the unit up on a ship or other place where DC is used.

AC mains lead protection

Ensure the AC mains lead is connected correctly and not damaged. Poor connection and lead damage can cause fire or electric shock. Do not pull, bend, or place heavy items on the lead.

Grasp the plug firmly when unplugging the lead. Pulling the AC mains lead can cause electric shock.

Do not handle the plug with wet hands. This can cause electric shock.

Foreign matter

Do not let metal objects fall inside the unit. This can cause electric shock or malfunction.

Do not let liquids get into the unit. This can cause electric shock or malfunction. If this occurs, immediately disconnect the unit from the power supply and contact your dealer.

Do not spray insecticides onto or into the unit. They contain flammable gases which can ignite if sprayed into the unit.

Service

Do not attempt to repair this unit by yourself. If sound is interrupted, indicators fail to light, smoke appears, or any other problem that is not covered in these instructions occurs, disconnect the AC mains lead and contact your dealer or an authorized service centre. Electric shock or damage to the unit can occur if the unit is repaired, disassembled or reconstructed by unqualified persons.

Extend operating life by disconnecting the unit from the power source if it is not to be used for a long time.

Manufactured under license from Dolby Laboratories.
Dolby and the double-D symbol are trademarks of Dolby Laboratories.

"DTS" is a registered trademark of DTS, Inc. and "DTS 2.0+ Digital Out" is a trademark of DTS, Inc.

This product incorporates copyright protection technology that is protected by U.S. patents and other intellectual property rights. Use of this copyright protection technology must be authorized by Macrovision, and is intended for home and other limited viewing uses only unless otherwise authorized by Macrovision. Reverse engineering or disassembly is prohibited.

- SDHC Logo is a trademark.
- Portions of this product are protected under copyright law and are provided under license by ARIS/SOLANA/4C.

Official DivX® Certified product.
Plays all versions of DivX® video (including DivX®6) with standard playback of DivX® media files.
DivX, DivX Certified, and associated logos are trademarks of DivX, Inc. and are used under license.

HDMI, the HDMI logo and High-Definition Multimedia Interface are trademarks or registered trademarks of HDMI Licensing LLC.

HDAVI Control™ is a trademark of Matsushita Electric Industrial Co., Ltd.

Gracenote® Corporate Description
 Music recognition technology and related data are provided by Gracenote®. Gracenote is the industry standard in music recognition technology and related content delivery. For more information visit www.gracenote.com.

Gracenote® Proprietary Legends
 CD and music-related data from Gracenote, Inc., copyright © 2007 Gracenote. Gracenote Software, copyright © 2007 Gracenote. This product and service may practice one or more of the following U.S. Patents: #5,987,525; #6,061,680; #6,154,773, #6,161,132, #6,230,192, #6,230,207, #6,240,459, #6,330,593, and other patents issued or pending. Some services supplied under license from Open Globe, Inc. for U.S. Patent: #6,304,523.

Gracenote and CDDB are registered trademarks of Gracenote. The Gracenote logo and logotype, and the “Powered by Gracenote” logo are trademarks of Gracenote.



Gracenote® End-User License Agreement

USE OF THIS PRODUCT IMPLIES ACCEPTANCE OF THE TERMS BELOW.

This application or device contains software from Gracenote, Inc. of Emeryville, California (“Gracenote”). The software from Gracenote (the “Gracenote Software”) enables this application to perform disc and/or file identification and obtain music-related information, including name, artist, track, and title information (“Gracenote Data”) from online servers or embedded databases (collectively, “Gracenote Servers”) and to perform other functions. You may use Gracenote Data only by means of the intended End-User functions of this application or device.

You agree that you will use Gracenote Data, the Gracenote Software, and Gracenote Servers for your own personal non-commercial use only. You agree not to assign, copy, transfer or transmit the Gracenote Software or any Gracenote Data to any third party. YOU AGREE NOT TO USE OR EXPLOIT GRACENOTE DATA, THE GRACENOTE SOFTWARE, OR GRACENOTE SERVERS, EXCEPT AS EXPRESSLY PERMITTED HEREIN.

You agree that your non-exclusive license to use the Gracenote Data, the Gracenote Software, and Gracenote Servers will terminate if you violate these restrictions. If your license terminates, you agree to cease any and all use of the Gracenote Data, the Gracenote Software, and Gracenote Servers. Gracenote reserves all rights in Gracenote Data, the Gracenote Software, and the Gracenote Servers, including all ownership rights. Under no circumstances will Gracenote become liable for any payment to you for any information that you provide. You agree that Gracenote, Inc. may enforce its rights under this Agreement against you directly in its own name.

The Gracenote service uses a unique identifier to track queries for statistical purposes. The purpose of a randomly assigned numeric identifier is to allow the Gracenote service to count queries without knowing anything about who you are. For more information, see the web page for the Gracenote Privacy Policy for the Gracenote service.

The Gracenote Software and each item of Gracenote Data are licensed to you “AS IS”
 Gracenote makes no representations or warranties, express or implied, regarding the accuracy of any Gracenote Data from in the Gracenote Servers. Gracenote reserves the right to delete data from the Gracenote Servers or to change data categories for any cause that Gracenote deems sufficient. No warranty is made that the Gracenote Software or Gracenote Servers are error-free or that functioning of Gracenote Software or Gracenote Servers will be uninterrupted. Gracenote is not obligated to provide you with new enhanced or additional data types or categories that Gracenote may provide in the future and is free to discontinue its services at any time.

GRACENOTE DISCLAIMS ALL WARRANTIES EXPRESS OR IMPLIED, INCLUDING, BUT NOT LIMITED TO, IMPLIED WARRANTIES OF MERCHANTABILITY, FITNESS FOR A PARTICULAR PURPOSE, TITLE, AND NON-INFRINGEMENT. GRACENOTE DOES NOT WARRANT THE RESULTS THAT WILL BE OBTAINED BY YOUR USE OF THE GRACENOTE SOFTWARE OR ANY GRACENOTE SERVER. IN NO CASE WILL GRACENOTE BE LIABLE FOR ANY CONSEQUENTIAL OR INCIDENTAL DAMAGES OR FOR ANY LOST PROFITS OR LOST REVENUES.

Adjust the audio quality (Sound menu)	55	Edit		Partial Delete	39
Adjust the picture quality (Picture menu)	54	Chapter	38	Pause Live TV	35
Album (CD)		Music on HDD	43	VIERA	37
Edit	43	Playlist	41	Playlist	40
Play	34	Still picture	42	Power Save	65
Album (Still picture)		Title	38	Progressive	54, 84
Edit	42	Enabling discs to be played on other equipment - Finalise	58	Properties	
Play	32			Music on HDD	34
Angle	54	Finalise	58, 84	Playlist	41
Aspect	9	Flexible Recording	22	Still picture	33, 42
Audio		Format	57, 84	Title	39
Digital broadcast (DVB Multi Audio)	55	FR (Flexible Recording Mode)	21	Protection	
Playback	28	FUNCTION MENU window	35	Album (Still picture)	42
Auto Renewal Recording	26	G-CODE	24	Card	56
AV2 Input	64	Gracenote® database	52	Cartridge	56
Change Thumbnail	39	Group (MP3)		Disc	56
Channel		Edit	43	Still picture	42
Select	15	GUIDE	18	Title	39
Settings	60	HDAVI Control	8, 36–37, 64, 69	Quick Start	65
Chapter	28, 38	HDMI	8, 64, 69, 84	Quick View	28
Chasing playback	22	High Speed Copy	61	Ratings level	61
Child Lock	67	Initialize	66	Recording	17
Cleaning		JPEG	13, 32–33, 84	Aspect	20, 61
Disc	14	Language		Auto Renewal	26
Lens	5	Code list	73	DV automatic recording	23
Main unit	5	Disc menu	61	Flexible Recording	22
Clock Settings	65	Soundtrack	54, 61	Important notes	20
Connection		Subtitle	54, 61	Mode	21
Aerial	8, 70–71	LPCM	62, 84	Relief	26
Amplifier, system component, receiver	69	Manual Skip	28	Timer	18, 24–27
DV input terminal	23	Menu		Relief Recording	26
HDMI	8, 69	DivX	30–31	Remote control code	65
Television	8, 68–71	MP3	31	Repeat Play	34, 54
Video cassette recorder	70–71	Setup	59	Resume play function	28
Copy		Mode		SD card	12
Music	52	Recording	21	Select channel	15
SD Video	49	Still Mode	62	Setup menu	59
Still picture	50	MP3	13, 31, 84	Signal Condition	60
Title/Playlist	45	Copy	52	Simultaneous rec and play	22
Copy (playlist)	41	Edit	43	Soundtrack	54
CPRM	84	Play	31, 34	Still picture	
Create Chapter	28, 39	Music on HDD		Copy	50
Create playlists	40	Copy	52	Edit	42
Delete		Edit	43	Play	32
Album (CD)	43	Play	34	Subtitle	
Album (Still picture)	42	Name		Disc	54
All titles	57	Album (CD)	43	Switch the audio/subtitles on the disc (Disc menu)	54
Chapter	39, 41	Album (Still picture)	42	System Update	66
Group (MP3)	43	Disc	56	Time Slip	28
Playlist	41	Entering text	44	Timer recording	18, 24–27
Still picture	42	Group (MP3)	43	Tuning	
Title	39	Playlist	41	Analogue broadcast	60
Track (MP3)	43	Title	24, 39	Digital broadcast	59
Digital Audio Output settings	62, 64	New service	15, 63	Settings	66
Digital broadcast				TV Guide	18
Digital channel information	15			TV System (PAL/NTSC)	64
DVB Multi Audio	55			USB	
New service	15, 63			Copy (Music)	52
Recording	17			Copy (SD Video)	49
Select the channel	15			Copy (Still picture)	50
Signal Condition	60			Insert	14
System Update	66			Play	30
Timer	18			Supported formats	12
Direct Navigator	29, 32, 38, 42			VIERA Link	8, 36–37, 64, 69
Discs	10–11				
Display					
Digital channel information	15				
Status messages	55				
Divide Title	39				
DivX	13, 30–31, 84				
DV automatic recording	23				
DVB Multi Audio					
Select audio	55				